

EXTRUSIONS AND TUBING

EXTRUSIONS AND TUBING

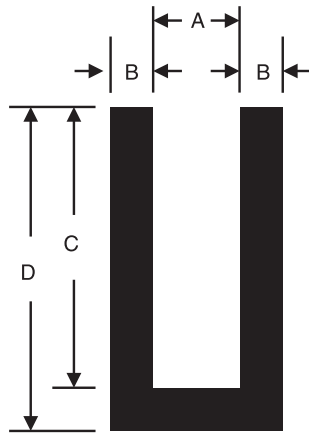

EXTRUSIONS AND TUBING



RPM Part Number	A Slot Diameter	B Leg Width	C Slot Depth	D Total Height
XU-0031-01	1/32	1/16	5/32	3/16
XU-0062-01	1/16	1/16	5/16	3/8
XU-0078-01	5/64	5/64	15/64	23/64
XU-0093-01	3/32	5/64	7/16	5/8
XU-0125-02	1/8	1/16	1/4	5/16
XU-0125-03	1/8	1/16	9/16	5/8

RPM Part Number	A Slot Diameter	B Leg Width	C Slot Depth	D Total Height
XU-0125-04	1/8	3/32	3/8	1/2
XU-0188-01	3/16	1/16	3/8	7/16
XU-0250-01	1/4	1/16	5/16	3/8
XU-0375-01	3/8	3/32	1/2	19/32
XU-0500-01	1/2	1/8	5/8	3/4
XU-0750-01	3/4	1/8	1-1/8	1-1/4

Measured in inches

XU-0031-02

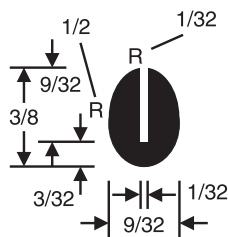

XU-0062-02

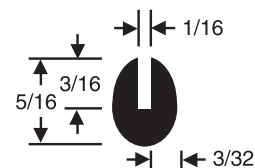

XU-0062-03

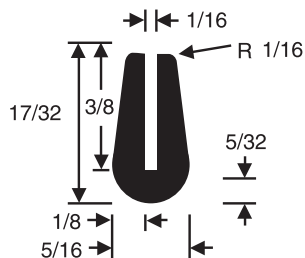

XU-0062-04

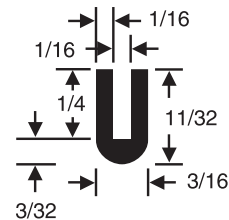

Measured in inches

EXTRUSIONS AND TUBING

XU-0109-01

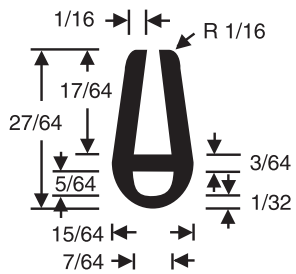

XU-0125-01

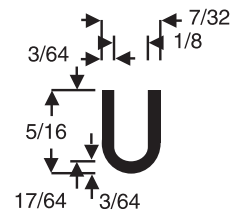

XU-0125-05

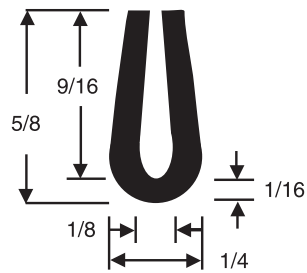

XU-0125-06

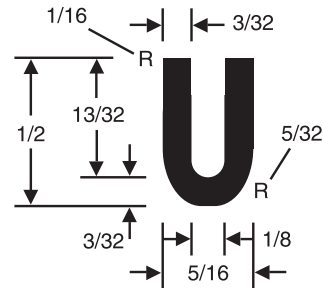

XU-0125-07

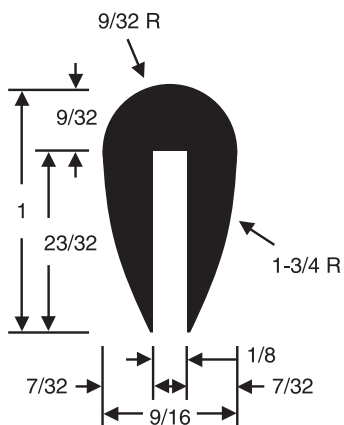

XU-0125-08

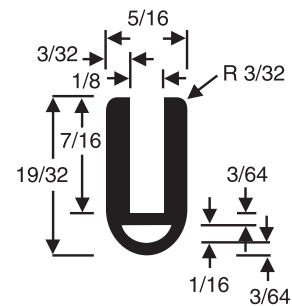

Measured in inches

EXTRUSIONS AND TUBING

XU-0188-02

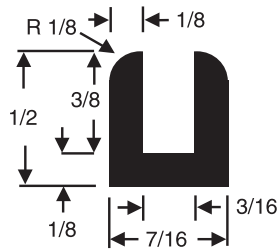

XU-0188-03

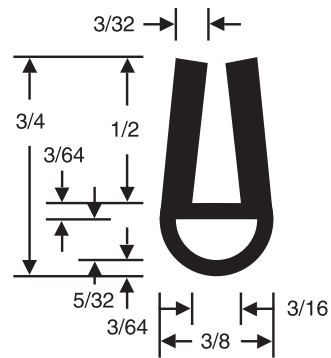

XL-0687-01

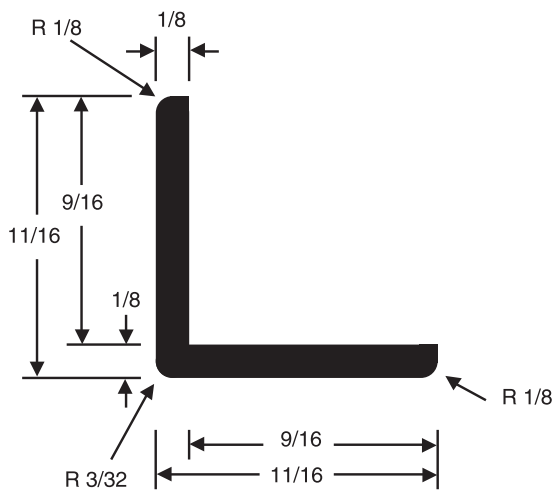

XP-0750-01

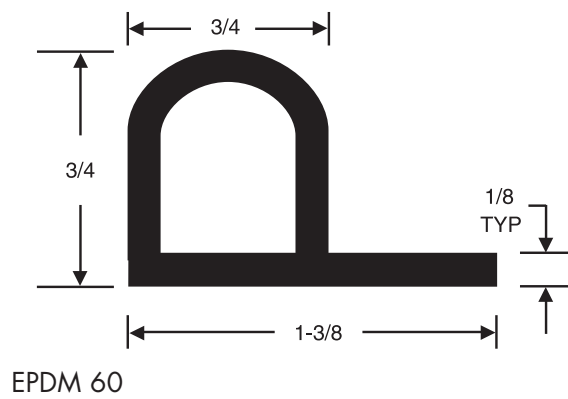

XP-0250-01

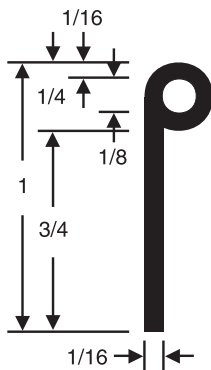

EPDM 60

XP-0375-01

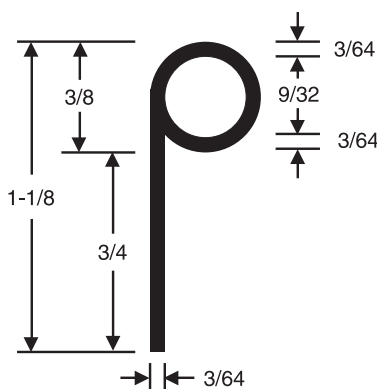

EPDM 60

XP-0500-01

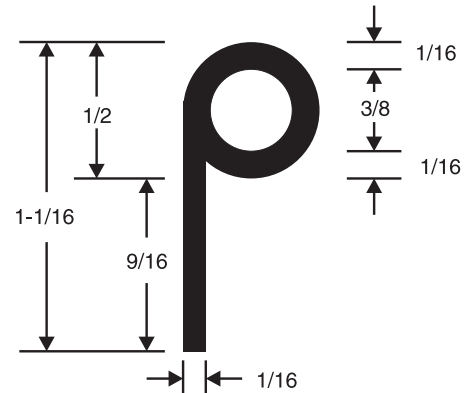

EPDM 60

Measured in inches

EXTRUSIONS AND TUBING

One Piece Weatherstrip

One-piece Self-Sealing Weatherstrips provide inexpensive fixed-window installation. They are easy to install, lock the glass in place and give an efficient seal. These Weatherstrips are available in 50 ft. coils. Exact lengths from 12" to 144" are available on special quotation.

The range of dimensions shown in the chart applies to average conditions. Rubber gaskets should be tried in each specific application to insure the desired results.

For easier assembly of lock strips, lubricate lock strip channel by brushing soapsuds such as a mixture of green soap diluted 3 or 4 to 1. Do not use detergents containing phosphates.

RPM Part Number	A Glass Panel Thickness	B Body Panel Thickness	Min. Recom. Clearance glass/body Opening	Overall Width Installed	Min. Recom. Radius of Panel Opening	Weight Per Foot (lbs.)
XLC-101	.1875 to .250	.035 to .067	.3125	.750	2.5	.256
XLC-102	.1875 to .250	.062 to .093	.3125	.750	2.0	.261
XLC-103	.1875 to .250	.093 to .140	.3125	.750	2.5	.288
XLC-104	.1875 to .250	.1875 to .250	.406	.750	3.5	.288

XLC-101



XLC-102



XLC-103



XLC-104



Measured in inches

EXTRUSIONS AND TUBING

Edge Protectors

Vinyl Edge Protectors for a variety of metal thicknesses.
(A) Vinyl Cover (B) Wire Cover

XTRM-101

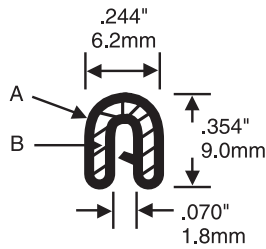

Flange Range 0.035 - 0.045"

XTRM-102

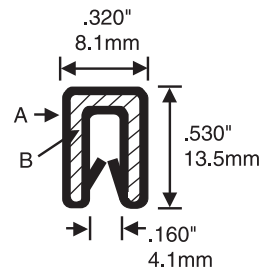

Flange Range 0.040 - 0.100"

XTRM-103

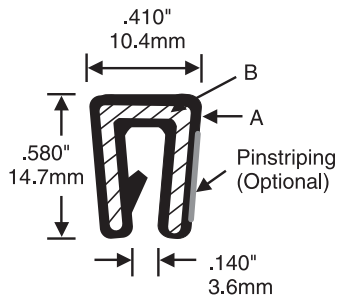

Flange Range 0.080 - 0.140"

XTRM-104

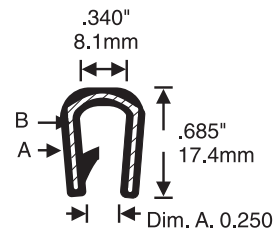

Flange Range 0.200 - 0.245"

XTRM-105

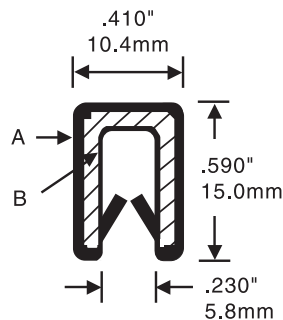

Flange Range 0.070 - 0.130"

EXTRUSIONS AND TUBING

Rubber and Sponge Bulb Seals

(A) EPDM Sponge (B) EPDM Rubber Cover (C) Wire Carrier

XBS-101

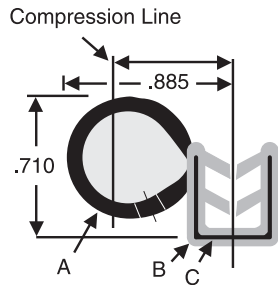

Flange Range 0.045 - 0.135

XBS-102

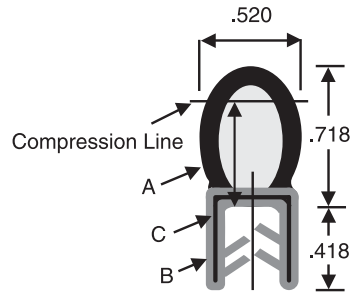

Flange Range 0.035 - 0.125

XBS-103

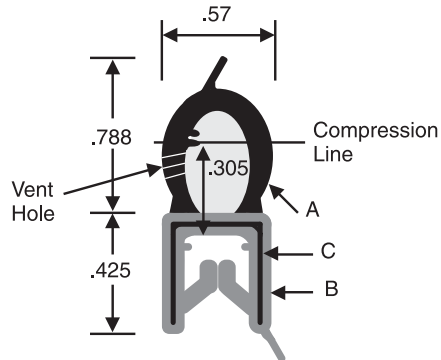

Flange Range 0.040 - 0.100

Measured in inches

UNABLE TO FIND THE PART YOU REQUIRE?

Contact our customer service representative for information on the many additional standard or custom parts we have available.

EXTRUSIONS AND TUBING

Sponge Rubber Seals

RPM Multi-purpose Sponge Rubber Seals

Applications:

Dust proofs, fills voids, weather proofs, dampens sound, isolates vibration and insulates.

Sponge Cord

RPM Part Number	Diameter (inches)	Square Cord (inches)
NSC-125-FT	0.125	—
NSC-188-FT	0.188	—
NSC-250-FT	0.250	0.250
NSC-313-FT	0.313	—

RPM Part Number	Diameter (inches)	Square Cord (inches)
NSC-375-FT	0.375	0.375
NSC-500-FT	0.500	0.500
NSC-750-FT	0.750	—
NSC-1000-FT	1.000	—

XSP-101-A

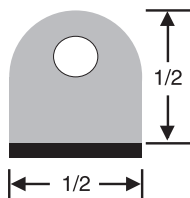

XSP-102-A

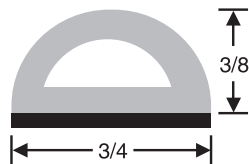

XSP-103-A

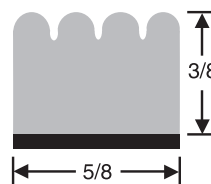

XSP-104-A

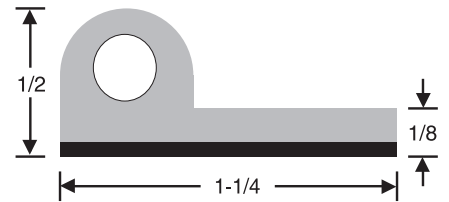

Sponge rubber seals complete with adhesive backing.

Measured in inches

Neoprene Tubing

RPM Part Number	ID x (inches)	Wall (inches)
NET-1/8 x 1/16	1/8	1/16
NET-3/16 x 1/16	3/16	1/16
NET-1/4 x 1/16	1/4	1/16
NET-1/4 x 1/8	1/4	1/8
NET-5/16 x 1/16	5/16	1/16
NET-3/8 x 1/16	3/8	1/16

RPM Part Number	ID x (inches)	Wall (inches)
NET-3/8 x 1/8	3/8	1/8
NET-1/2 x 1/8	1/2	1/8
NET-5/8 x 1/8	5/8	1/8
NET-3/4 x 1/8	3/4	1/8
NET-1 x 1/8	1	1/8

Tubings available on request: Latex, Pure Gum, Silicone, Fluorocarbon, EPDM and FDA materials. Custom sizes also available.