

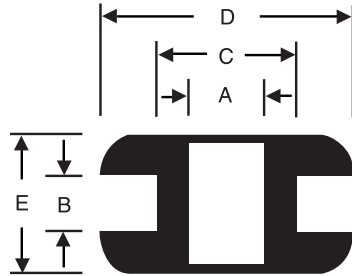

GROMMETS

Military Standard Grommets



MS-35489 Military Standard Grommets

Supersedes AN-931. Rubber, hot-oil and coolant resistant material specification MIL-G-3036.

AN-931 Army-Navy Standard Grommets

To procurement specification AN-G-21. Rubber, hot-oil and coolant resistant material specification MIL-G-3036.

Round Shoulders Unequal Width

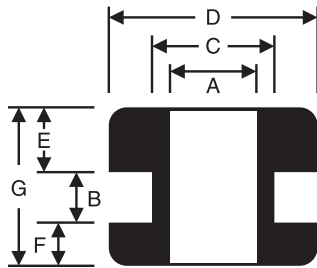

RPM Part Number	A Bore Diameter	B Groove Width	C Groove Diameter	D Outside Diameter	E Shoulder Sm. Width	F Shoulder Lrg. Width	G Overall Thickness
GRO-0156-03	5/32	1/16	9/32	15/32	7/64	1/8	19/64
GRO-0250-10	1/4	1/16	9/16	3/4	3/64	1/16	11/64
GRO-0250-11	1/4	3/32	7/16	5/8	3/32	3/16	3/8

Measured in inches

GROMMETS

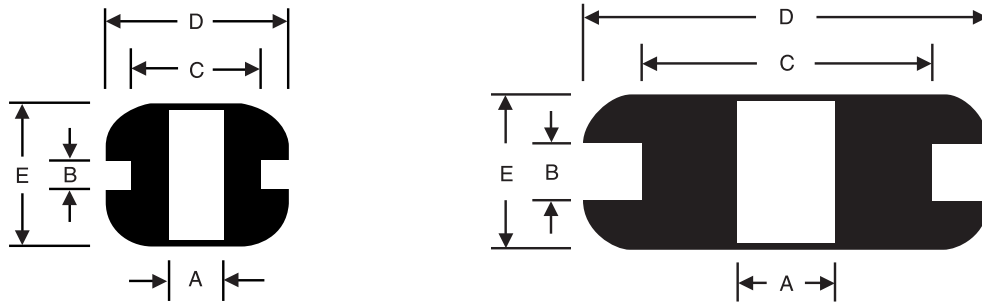

RPM Part Number	A Bore Diameter	B Groove Width	C Groove Diameter	D Outside Diameter	E Overall Thickness
GRO-0109-01	7/64	3/64	1/2	11/16	9/32
GRO-0125-01	1/8	1/32	3/16	1/4	3/32
GRO-0125-02	1/8	1/16	1/4	11/32	3/16
GRO-0125-03	1/8	3/32	3/8	1/2	5/16
GRO-0156-01	5/32	1/16	1/4	3/8	3/16
GRO-0156-02	5/32	3/32	1/4	7/16	3/8
GRO-0188-01	3/16	1/32	5/16	7/16	7/32
GRO-0188-03	3/16	1/16	5/16	7/16	3/16
GRO-0188-04	3/16	1/16	5/16	1/2	1/4
GRO-0188-05	3/16	1/16	9/16	3/4	3/16
GRO-0188-06	3/16	3/32	9/32	7/16	7/32
GRO-0188-07	3/16	1/8	5/16	7/16	1/4
GRO-0188-08	3/16	3/16	5/16	7/16	5/16
GRO-0188-09	3/16	1/4	5/16	7/16	3/8
GRO-0188-11	3/16	1/8	9/16	3/4	1/4
GRO-0203-01	13/64	1/8	13/32	9/16	3/8
GRO-0218-01	7/32	1/16	5/16	7/16	3/16
GRO-0250-01	1/4	1/16	3/8	1/2	1/4
GRO-0250-02	1/4	1/16	7/16	5/8	3/16
GRO-0250-03	1/4	1/16	1	1-1/4	1/4
GRO-0250-04	1/4	3/32	3/8+	1/2	1/4
GRO-0250-05	1/4	1/8	3/8+	1/2	9/32
GRO-0250-06	1/4	1/8	7/16	5/8	1/4
GRO-0250-07	1/4	3/16	7/16	5/8	5/16
GRO-0250-08	1/4	1/4	7/16	5/8	3/8
GRO-0281-01	9/32	1/16	3/8	9/16	1/4
GRO-0281-02	9/32	1/4	15/32	11/16	7/16
GRO-0313-01	5/16	1/16	7/16	5/8	9/32
GRO-0313-02	5/16	1/16	9/16	13/16	5/16
GRO-0313-03	5/16	1/16	3/4	1	5/16
GRO-0313-04	5/16	3/32	7/16	5/8	5/16
GRO-0313-05	5/16	1/8	9/16	13/16	3/8
GRO-0313-06	5/16	1/8	3/4	1	3/8
GRO-0313-07	5/16	3/16	9/16	13/16	7/16
GRO-0313-08	5/16	3/16	3/4	1	7/16

Measured in inches

GROMMETS

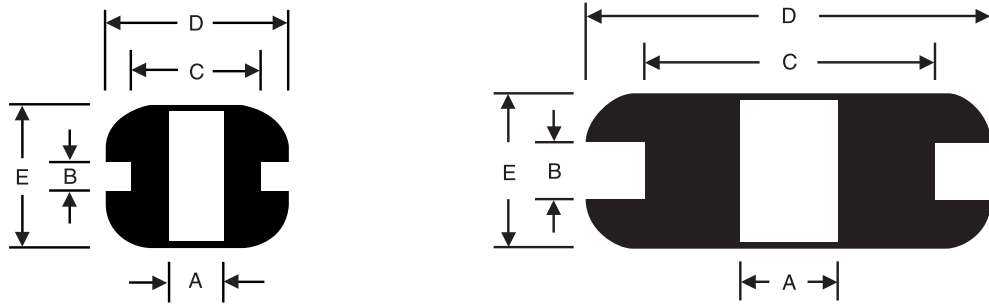

RPM Part Number	A Bore Diameter	B Groove Width	C Groove Diameter	D Outside Diameter	E Overall Thickness
GRO-0313-09	5/16	1/4	9/16	13/16	1/2
GRO-0313-10	5/16	1/4	3/4	1	1/2
GRO-0375-01	3/8	1/16	1/2	5/8	1/4
GRO-0375-02	3/8	1/16	1/2	11/16	9/32
GRO-0375-03	3/8	1/16	5/8	7/8	5/16
GRO-0375-04	3/8	1/16	1	1-1/4	1/4
GRO-0375-05	3/8	1/8	5/8	7/8	3/8
GRO-0375-06	3/8	3/16	5/8	7/8	7/16
GRO-0375-07	3/8	1/4	1/2	3/4	1/2
GRO-0375-08	3/8	1/4	5/8	7/8	1/2
GRO-0437-01	7/16	1/16	9/16	3/4	1/4
GRO-0437-02	7/16	1/16	11/16	15/16	5/16
GRO-0437-03	7/16	1/8	11/16	15/16	3/8
GRO-0437-04	7/16	3/16	9/16	11/16	3/8
GRO-0437-05	7/16	3/16	11/16	15/16	7/16
GRO-0437-06	7/16	1/4	11/16	15/16	1/2
GRO-0500-01	1/2	1/16	13/16	1-1/16	5/16
GRO-0500-02	1/2	1/16	1	1-1/4	1/4
GRO-0500-03	1/2	1/16	1-1/4	1-1/2	1/4
GRO-0500-04	1/2	3/32	3/4	31/32	9/32
GRO-0500-05	1/2	1/8	3/4	1	1/2
GRO-0500-06	1/2	3/16	13/16	1-1/16	7/16
GRO-0500-07	1/2	1/4	13/16	1-1/16	1/2
GRO-0500-08	1/2	3/8	3/4	1	5/8
GRO-0500-12	1/2	1/8	13/16	1-1/16	3/8
GRO-0562-01	9/16	1/16	13/16	1-1/16	5/16
GRO-0562-02	9/16	3/16	7/8	1-1/16	7/16
GRO-0562-03	9/16	1/4	13/16	1-1/16	1/2
GRO-0562-04	9/16	3/8	7/8	1-1/16	5/8
GRO-0562-05	9/16	1	13/16	1-1/8	1-1/4
GRO-0562-06	9/16	1/8	13/16	1-1/16	3/8
GRO-0625-01	5/8	1/16	7/8	1-1/8	5/16
GRO-0625-02	5/8	1/16	1-1/4	1-1/2	1/4
GRO-0625-03	5/8	1/8	7/8	1-1/8	3/8
GRO-0625-04	5/8	3/16	7/8	1-1/8	7/16

Measured in inches

GROMMETS

RPM Part Number	A Bore Diameter	B Groove Width	C Groove Diameter	D Outside Diameter	E Overall Thickness
GRO-0625-05	5/8	1/4	7/8	1-1/8	1/2
GRO-0687-01	11/16	1/16	1	1-5/16	3/8
GRO-0687-02	11/16	1/8	1	1-5/16	7/16
GRO-0687-03	11/16	3/16	1	1-5/16	1/2
GRO-0687-04	11/16	1/4	1	1-5/16	9/16
GRO-0750-01	3/4	1/16	1-1/16	1-3/8	3/8
GRO-0750-02	3/4	1/16	1-1/4	1-5/8	1/4
GRO-0750-03	3/4	1/16	1-7/16	1-13/16	3/8
GRO-0750-04	3/4	1/8	1-1/16	1-3/8	7/16
GRO-0750-05	3/4	3/16	1-1/16	1-3/8	1/2
GRO-0750-06	3/4	1/4	1-1/16	1-3/8	9/16
GRO-0875-01	7/8	1/16	1-1/4	1-5/8	7/16
GRO-0875-02	7/8	1/16	1-5/8	2	7/16
GRO-0875-03	7/8	5/64	1-3/16	1-3/8	15/32
GRO-0875-04	7/8	1/8	1-1/4	1-5/8	1/2
GRO-0875-05	7/8	9/64	1-3/16	1-3/8	15/32
GRO-0875-06	7/8	3/16	1-1/4	1-5/8	9/16
GRO-0875-07	7/8	1/4	1-1/4	1-5/8	5/8
GRO-1000-01	1	1/16	1-3/8	1-3/4	7/16
GRO-1000-02	1	1/8	1-3/8	1-3/4	1/2
GRO-1000-03	1	3/16	1-3/8	1-3/4	9/16
GRO-1000-04	1	1/4	1-1/4	1-1/2	1/2
GRO-1000-05	1	1/4	1-3/8	1-3/4	5/8
GRO-1125-01	1-1/8	1/16	1-1/2	1-7/8	3/8
GRO-1250-01	1-1/4	3/32	1-1/2	1-7/8	3/8
GRO-1313-01	1-5/16	1/16	1-5/8	2	3/8
GRO-1313-02	1-5/16	1/8	1-5/8	2	7/16
GRO-1500-01	1-1/2	1/16	1-3/4	2-1/8	7/16
GRO-1500-02	1-1/2	3/32	2	2-3/8	3/8
GRO-1500-03	1-1/2	1/8	1-3/4	2-1/8	1/2
GRO-1500-04	1-1/2	3/16	1-3/4	2-1/8	9/16
GRO-1500-05	1-1/2	1/4	1-3/4	2-1/8	5/8
GRO-2125-01	2-1/8	1/16	2-1/2	2-7/8	7/16
GRO-2125-02	2-1/8	1/8	2-1/2	2-7/8	1/2

Measured in inches

GROMMETS

Unequal Shoulders Diameter

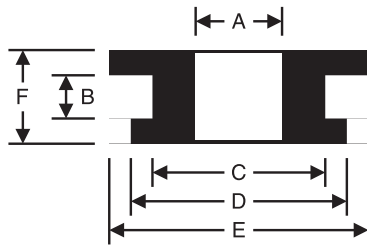

RPM Part Number	A Bore Diameter	B Groove Width	C Groove Diameter	D Shoulder Sm. Diameter	E Shoulder Lrg. Diameter	F Overall Thickness
GRO-0500-09	1/2	3/32	1-3/8	1-5/8	1-7/8	1/4
GRO-0625-06	5/8	3/32	1-3/8	1-5/8	1-7/8	1/4

Measured in inches

Plain Bore Square Shoulders

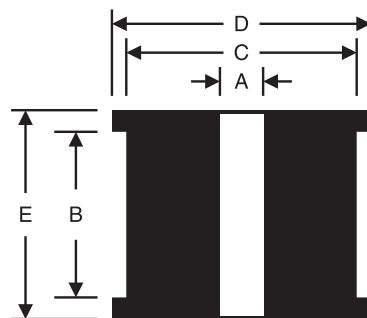

RPM Part Number	A Bore Diameter	B Groove Width	C Groove Diameter	D Outside Diameter	E Overall Thickness
GRO-0313-11	5/16	3/8	3/8	9/16	1/2
GRO-0375-09	3/8	1/8	1/2	5/8	13/32
GRO-0625-07	5/8	5/8	7/8	1-1/16	7/8

Measured in inches

GROMMETS

GRO-0188-10

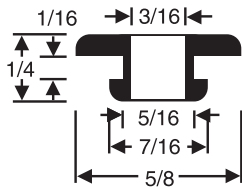

GRO-0375-10

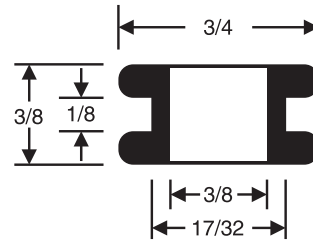

Plain Bore Rolled Shoulders

GRO-0500-10

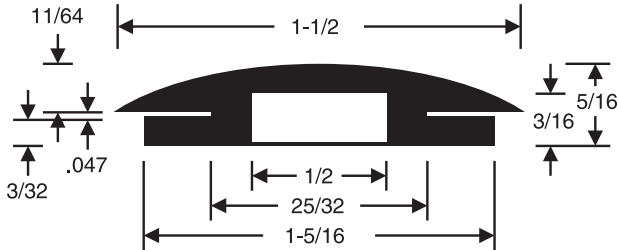

GRO-0500-11

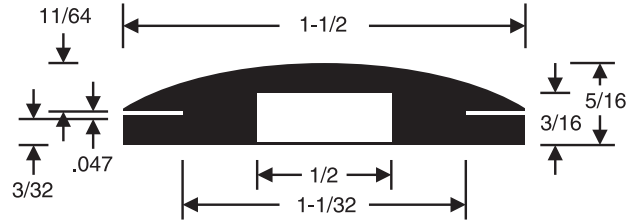

GRO-0625-08

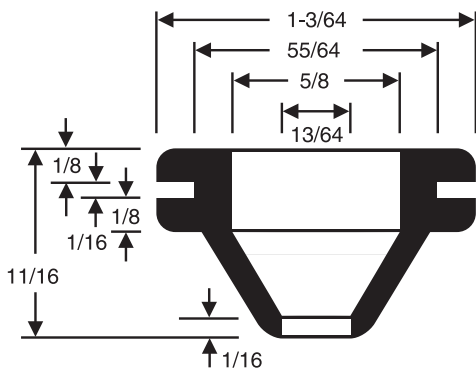

GRO-0687-05

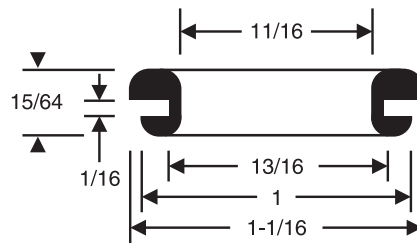

Chamfered Bore Rounded Shoulders

Measured in inches

GROMMETS

GRO-0750-07

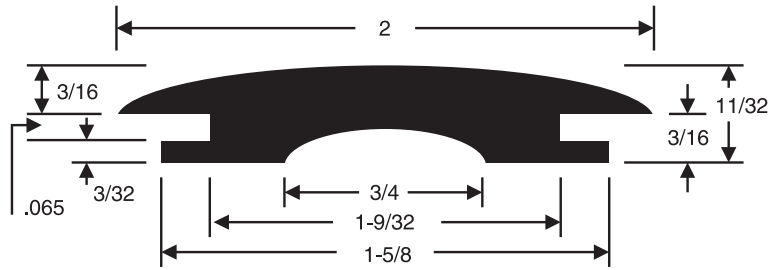

GRO-0750-08

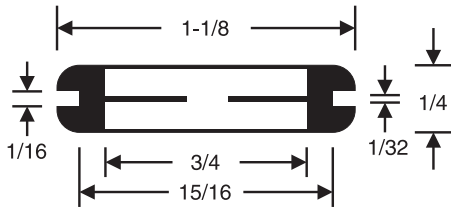

GRO-1016-01

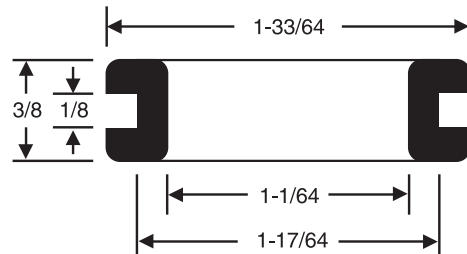

Chamfered Bore Rounded Shoulders

GRO-2000-01

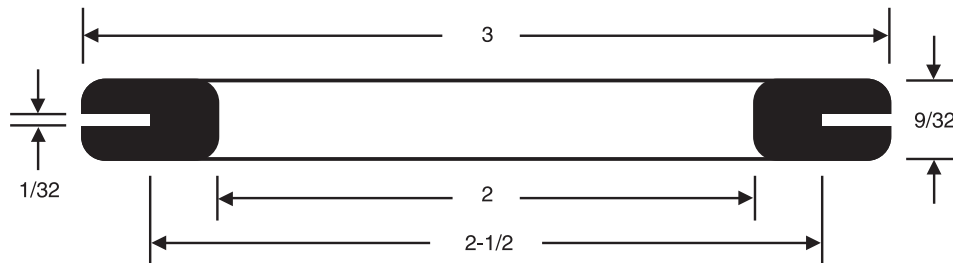

Chamfered Bore

Measured in inches

UNABLE TO FIND THE PART YOU REQUIRE?

Contact our customer service representative for information on the many additional standard or custom parts we have available.