

106PHL-6 Multiplane Mounts Holder



Item # 106PHL-6 Multiplane Mounts Holder

Manufacturer: Parker Lord Corporation

Specifications

A (in)	1
Axial Static Spring Rate (lbs/in)	32
Axial Static Spring Rate (Metric)	5.6
B (in)	1.25
C (in)	1
D (in)	0.166
E (in)	0.141
Enclosure Shape	Holder
F (in)	0.032
F (mm)	0.8
G (in)	0.53
G (mm)	13.5
I (in)	0.84

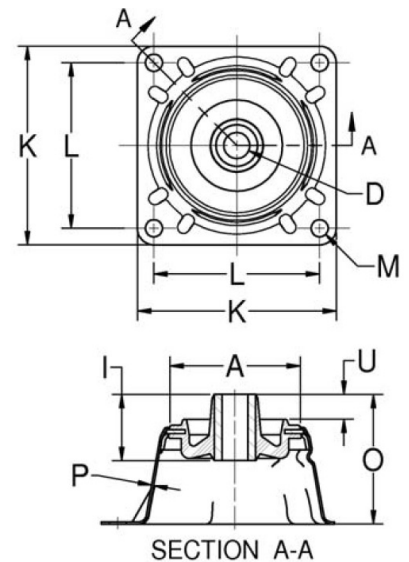

Lord Platform Mounts provide effective isolation against vibration. The contour of the flexing element was developed to provide uniform stress distribution. This, plus high strength bonding and the use of specially compounded elastomers, provides



[Request for Quote](#)

[Contact Us](#)

USA
4392 Broadway
Depew, NY 14043

Canada
2290 Industrial Street
Burlington, Ontario
L7P 1A1

888.842.5668

905.335.5523

info@rpmrubberparts.com

Mounts, offer a range in load ratings from 0.5 to 600 pounds. Snubbing washers provide an interlocking system of metal parts which act to prevent damage from overload or excessive shock impact. Lord Plateform Mounts are easy to install and provide space efficiency. Typical applications include electronic equipment, business machines, medical equipment and small pumps, engines and gen sets.



[Request for Quote](#)

[Contact Us](#)

 **USA**
4392 Broadway
Depew, NY 14043

 **Canada**
2290 Industrial Street
Burlington, Ontario
L7P 1A1

 888.842.5668

 905.335.5523

 info@rpmrubberparts.com



106PHL-6 Multiplane Mounts Holder



Item # 106PHL-6 Multiplane Mounts Holder
Manufacturer: Parker Lord Corporation

Specifications (Continued)

I (mm)	21.3
Inside Diameter (in)	0.17
K (in)	1.69
K (mm)	42.9
M (in)	0.141
M (mm)	3.6
Manufacturer	Parker LORD
Material	Aluminum
Max Axial Load Rating (lbs)	6
Max Axial Load Rating (Metric)	27
Max Axial Rated Load at 1/16 in (1.58 mm) Deflection (lbs)	6
Max Axial Rated Load at 1/16 in (1.58 mm) Deflection (Metric)	27
O (in)	1.414

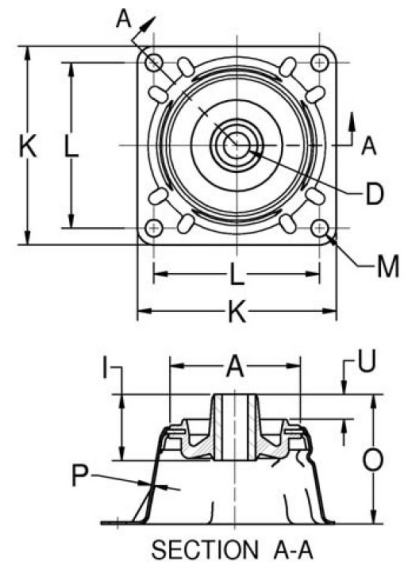

Lord Platform Mounts provide effective isolation against vibration. The contour of the flexing element was developed to provide uniform stress distribution. This, plus high strength bonding and the use of specially compounded elastomers, provides

[Request for Quote](#)
[Contact Us](#)

USA
 4392 Broadway
 Depew, NY 14043

Canada
 2290 Industrial Street
 Burlington, Ontario
 L7P 1A1

☎ 888.842.5668

☎ 905.335.5523

✉ info@rpmrubberparts.com



Mounts, offer a range in load ratings from 0.5 to 600 pounds. Snubbing washers provide an interlocking system of metal parts which act to prevent damage from overload or excessive shock impact. Lord Plateform Mounts are easy to install and provide space efficiency. Typical applications include electronic equipment, business machines, medical equipment and small pumps, engines and gen sets.



[Request for Quote](#)

[Contact Us](#)

 **USA**
4392 Broadway
Depew, NY 14043

 **Canada**
2290 Industrial Street
Burlington, Ontario
L7P 1A1

 888.842.5668

 905.335.5523

 info@rpmrubberparts.com



106PHL-6 Multiplane Mounts Holder



Item # 106PHL-6 Multiplane Mounts Holder
Manufacturer: Parker Lord Corporation

Specifications (Continued)

O (mm)	40.1
Outside Diameter (in)	0.88
Outside Diameter (mm)	22.4
P (in)	0.025
P (mm)	0.6
Q (in)	1.414
Q (mm)	35.9
R (in)	0.62
R (mm)	15.7
Recommended Steel Washer	J-2049-1
S (in)	1.66
S (mm)	42.2
Series	106

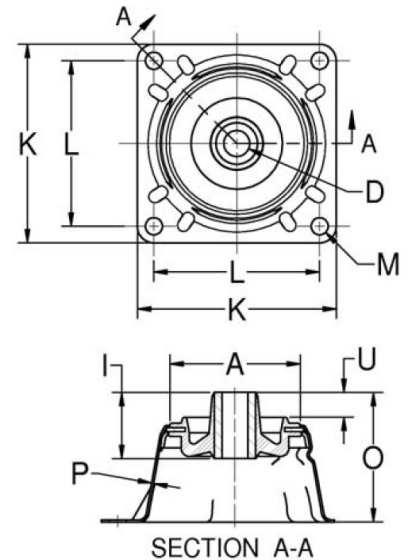

Lord Platform Mounts provide effective isolation against vibration. The contour of the flexing element was developed to provide uniform stress distribution. This, plus high strength bonding and the use of specially compounded elastomers, provides

[Request for Quote](#)
[Contact Us](#)

USA
 4392 Broadway
 Depew, NY 14043

Canada
 2290 Industrial Street
 Burlington, Ontario
 L7P 1A1

☎ 888.842.5668

☎ 905.335.5523

✉ info@rpmrubberparts.com



Mounts, offer a range in load ratings from 0.5 to 600 pounds. Snubbing washers provide an interlocking system of metal parts which act to prevent damage from overload or excessive shock impact. Lord Plateform Mounts are easy to install and provide space efficiency. Typical applications include electronic equipment, business machines, medical equipment and small pumps, engines and gen sets.



[Request for Quote](#)

[Contact Us](#)

 **USA**
4392 Broadway
Depew, NY 14043

 **Canada**
2290 Industrial Street
Burlington, Ontario
L7P 1A1

 888.842.5668

 905.335.5523

 info@rpmrubberparts.com



106PHL-6 Multiplane Mounts Holder



Item # 106PHL-6 Multiplane Mounts Holder
Manufacturer: Parker Lord Corporation

Specifications (Continued)

Thickness (in)	0.032
Thickness (Metric)	0.8
U (in)	0.38
U (mm)	9.7

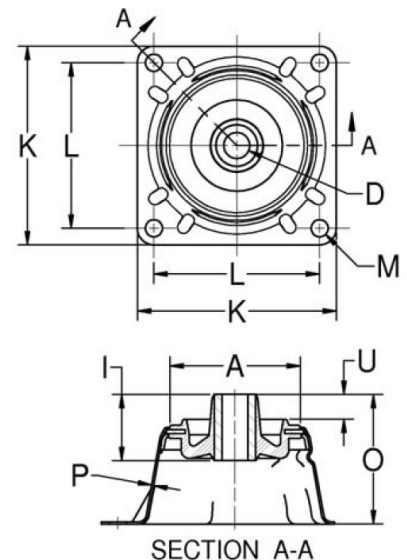

Lord Platform Mounts provide effective isolation against vibration. The contour of the flexing element was developed to provide uniform stress distribution. This, plus high strength bonding and the use of specially compounded elastomers, provides



[Request for Quote](#)

[Contact Us](#)

USA
 4392 Broadway
 Depew, NY 14043

Canada
 2290 Industrial Street
 Burlington, Ontario
 L7P 1A1

☎ 888.842.5668
 ☎ 905.335.5523
 ✉ info@rpmrubberparts.com



Mounts, offer a range in load ratings from 0.5 to 600 pounds. Snubbing washers provide an interlocking system of metal parts which act to prevent damage from overload or excessive shock impact. Lord Plateform Mounts are easy to install and provide space efficiency. Typical applications include electronic equipment, business machines, medical equipment and small pumps, engines and gen sets.



[Request for Quote](#)

[Contact Us](#)

 **USA**
4392 Broadway
Depew, NY 14043

 **Canada**
2290 Industrial Street
Burlington, Ontario
L7P 1A1

 888.842.5668

 905.335.5523

 info@rpmrubberparts.com

