

# 150PH-6 Platform Mounts Holder



Item # 150PH-6 Platform Mounts Holder

Manufacturer: Parker Lord Corporation

## Specifications

A (in)	1.5
Axial Static Spring Rate (lbs/in)	96
Axial Static Spring Rate (Metric)	16.8
B (in)	1.75
C (in)	1.375
D (in)	0.257
E (in)	0.166
Enclosure Shape	Holder
F (in)	0.05
F (mm)	1.3
G (in)	0.4
G (mm)	10.2
I (in)	0.62

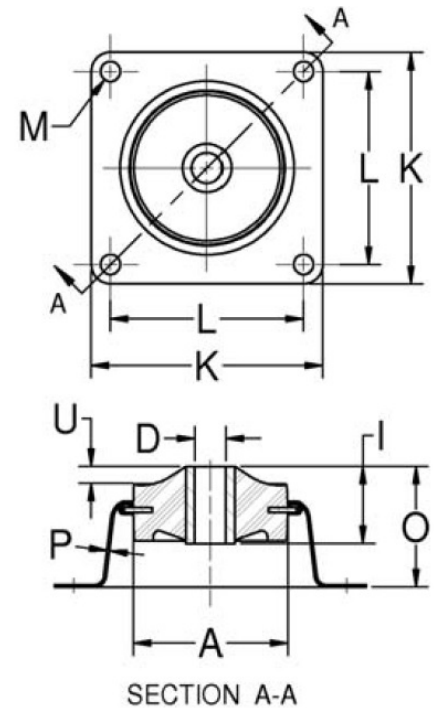

Lord Platform Mounts provide effective isolation against vibration. The contour of the flexing element was developed to provide uniform stress



[Request for Quote](#)

[Contact Us](#)

**USA**  
4392 Broadway  
Depew, NY 14043

**Canada**  
2290 Industrial Street  
Burlington, Ontario  
L7P 1A1

888.842.5668

905.335.5523

[info@rpmrubberparts.com](mailto:info@rpmrubberparts.com)

variety of design requirements. The three types, Plateform Mounts, Heavy-Duty Plateform Mounts and Multiplane Mounts, offer a range in load ratings from 0.5 to 600 pounds. Snubbing washers provide an interlocking system of metal parts which act to prevent damage from overload or excessive shock impact. Lord Plateform Mounts are easy to install and provide space efficiency. Typical applications include electronic equipment, business machines, medical equipment and small pumps, engines and gen sets.



[Request for Quote](#)

[Contact Us](#)

 **USA**  
4392 Broadway  
Depew, NY 14043

 **Canada**  
2290 Industrial Street  
Burlington, Ontario  
L7P 1A1

 888.842.5668

 905.335.5523

 [info@rpmrubberparts.com](mailto:info@rpmrubberparts.com)



# 150PH-6 Platform Mounts Holder



Item # 150PH-6 Platform Mounts Holder

Manufacturer: Parker Lord Corporation

## Specifications (Continued)

I (mm)	15.7
Inside Diameter (in)	0.26
K (in)	1.938
K (mm)	60.5
M (in)	0.196
M (mm)	5
Manufacturer	Parker LORD
Material	Steel
Max Axial Load Rating (lbs)	6
Max Axial Load Rating (Metric)	27
Max Axial Rated Load at 1/16 in (1.58 mm) Deflection (lbs)	6
Max Axial Rated Load at 1/16 in (1.58 mm) Deflection (Metric)	27
O (in)	1.12

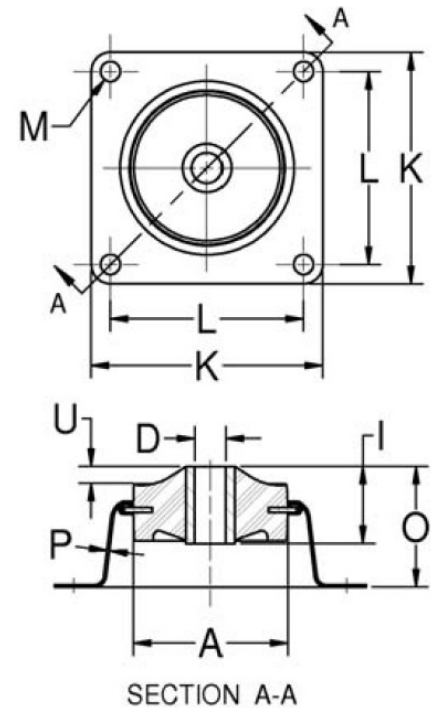

Lord Platform Mounts provide effective isolation against vibration. The contour of the flexing element was developed to provide uniform stress



[Request for Quote](#)

[Contact Us](#)

**USA**  
4392 Broadway  
Depew, NY 14043

**Canada**  
2290 Industrial Street  
Burlington, Ontario  
L7P 1A1

888.842.5668

905.335.5523

[info@rpmrubberparts.com](mailto:info@rpmrubberparts.com)

variety of design requirements. The three types, Plateform Mounts, Heavy-Duty Plateform Mounts and Multiplane Mounts, offer a range in load ratings from 0.5 to 600 pounds. Snubbing washers provide an interlocking system of metal parts which act to prevent damage from overload or excessive shock impact. Lord Plateform Mounts are easy to install and provide space efficiency. Typical applications include electronic equipment, business machines, medical equipment and small pumps, engines and gen sets.



[Request for Quote](#)

[Contact Us](#)

 **USA**  
4392 Broadway  
Depew, NY 14043

 **Canada**  
2290 Industrial Street  
Burlington, Ontario  
L7P 1A1

 888.842.5668

 905.335.5523

 [info@rpmrubberparts.com](mailto:info@rpmrubberparts.com)



# 150PH-6 Platform Mounts Holder



Item # 150PH-6 Platform Mounts Holder

Manufacturer: Parker Lord Corporation

## Specifications (Continued)

O (mm)	28.4
Outside Diameter (in)	1.38
Outside Diameter (mm)	35.1
P (in)	0.032
P (mm)	0.8
Q (in)	1.945
Q (mm)	49.4
R (in)	0.88
R (mm)	22.4
Recommended Steel Washer	J-2049-2
S (in)	2.32
S (mm)	58.9
Series	150

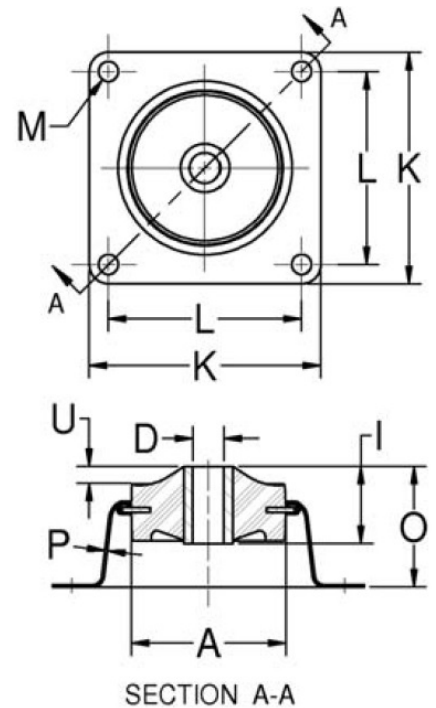

Lord Platform Mounts provide effective isolation against vibration. The contour of the flexing element was developed to provide uniform stress



[Request for Quote](#)

[Contact Us](#)

**USA**  
4392 Broadway  
Depew, NY 14043

**Canada**  
2290 Industrial Street  
Burlington, Ontario  
L7P 1A1

888.842.5668

905.335.5523

[info@rpmrubberparts.com](mailto:info@rpmrubberparts.com)

variety of design requirements. The three types, Plateform Mounts, Heavy-Duty Plateform Mounts and Multiplane Mounts, offer a range in load ratings from 0.5 to 600 pounds. Snubbing washers provide an interlocking system of metal parts which act to prevent damage from overload or excessive shock impact. Lord Plateform Mounts are easy to install and provide space efficiency. Typical applications include electronic equipment, business machines, medical equipment and small pumps, engines and gen sets.



[Request for Quote](#)

[Contact Us](#)

 **USA**  
4392 Broadway  
Depew, NY 14043

 **Canada**  
2290 Industrial Street  
Burlington, Ontario  
L7P 1A1

 888.842.5668

 905.335.5523

 [info@rpmrubberparts.com](mailto:info@rpmrubberparts.com)



# 150PH-6 Platform Mounts Holder



**Item #** 150PH-6 Platform Mounts Holder  
**Manufacturer:** Parker Lord Corporation

## Specifications (Continued)

Thickness (in)	0.05
Thickness (Metric)	1.3
U (in)	0.18
U (mm)	4.6

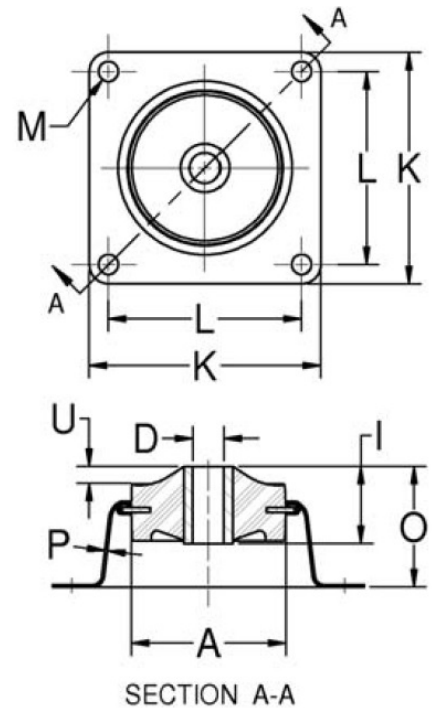

Lord Platform Mounts provide effective isolation against vibration. The contour of the flexing element was developed to provide uniform stress



[Request for Quote](#)

[Contact Us](#)

**USA**  
 4392 Broadway  
 Depew, NY 14043

**Canada**  
 2290 Industrial Street  
 Burlington, Ontario  
 L7P 1A1

☎ 888.842.5668  
 ☎ 905.335.5523  
 ✉ info@rpmrubberparts.com



variety of design requirements. The three types, Plateform Mounts, Heavy-Duty Plateform Mounts and Multiplane Mounts, offer a range in load ratings from 0.5 to 600 pounds. Snubbing washers provide an interlocking system of metal parts which act to prevent damage from overload or excessive shock impact. Lord Plateform Mounts are easy to install and provide space efficiency. Typical applications include electronic equipment, business machines, medical equipment and small pumps, engines and gen sets.



[Request for Quote](#)

[Contact Us](#)

 **USA**  
4392 Broadway  
Depew, NY 14043

 **Canada**  
2290 Industrial Street  
Burlington, Ontario  
L7P 1A1

 888.842.5668

 905.335.5523

 [info@rpmrubberparts.com](mailto:info@rpmrubberparts.com)

