

CB-1120-3 Center Bonded Mounts Cb 1100 Series

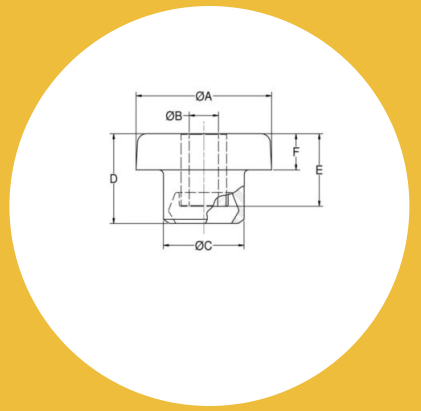

Item # CB-1120-3 Center Bonded Mounts Cb 1100 Series
Manufacturer: Parker Lord Corporation

Specifications

A (in)	1.09
Application Engineering Assistance	Frequently vibration isolation problems require a system engineering analysis. Lord has the computer capability as well as specialized programs for analyzing engine/transmission combinations.
B (in)	0.4
C (in)	0.81
D (in)	1.02
E (in)	0.62
F (in)	0.22
ID (in)	0.4
ID (mm)	10.2
Manufacturer	Parker LORD
Max Axial Deflection (in)	0.025
Max Axial Deflection (Metric)	0.64

Installation View

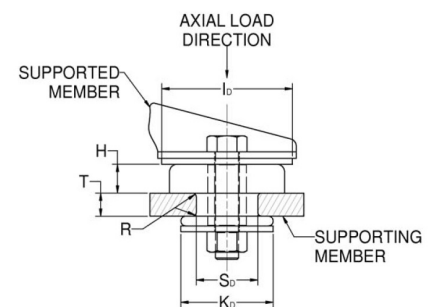

- Center Bonded Mounts isolate vibration, control shock and reduce noise due to structure borne vibrations. Available in a full range of rated load capacities and able to withstand shock loads of 10 g's, these mounts effectively protect equipment and improve operator comfort. They are ideal for automotive, marine, railroad and industrial markets.

Center Bonded Mounts provide flexible suspension systems for mobile transport-



[Request for Quote](#)

[Contact Us](#)

USA
 4392 Broadway
 Depew, NY 14043

Canada
 2290 Industrial Street
 Burlington, Ontario
 L7P 1A1

888.842.5668

905.335.5523

info@rpmrubberparts.com



oil-resistant elastomer are available.



[Request for Quote](#)

[Contact Us](#)

 **USA**
4392 Broadway
Depew, NY 14043

 **Canada**
2290 Industrial Street
Burlington, Ontario
L7P 1A1

 888.842.5668

 905.335.5523

 info@rpmrubberparts.com



CB-1120-3 Center Bonded Mounts Cb 1100 Series

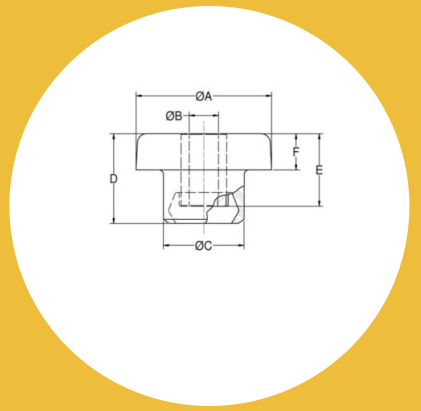

Item # CB-1120-3 Center Bonded Mounts Cb 1100 Series
Manufacturer: Parker Lord Corporation

Specifications (Continued)

Max Axial Static Load at Deflection (Metric)	560
Min Diameter ID (in)	1.25
Min Diameter (C) (Imperial)	31.8
Min Diameter KD (in)	1.12
Min Diameter KD (mm)	28.5
Nominal Dynamic Static Spring Rate Ratio	1.19
OD (E) (mm)	28.4
OD (in)	1.12
OD (mm)	28.4
R (in)	0.06
R (mm)	1.5
Recommended Bolt Grade or Class (SAE J1199)	5.8
Recommended Bolt Grade or Class (SAE J429)	2

Installation View

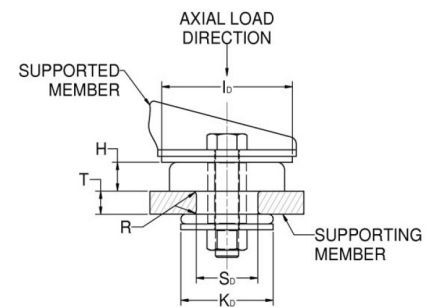

- Center Bonded Mounts isolate vibration, control shock and reduce noise due to structure borne vibrations. Available in a full range of rated load capacities and able to withstand shock loads of 10 g's, these mounts effectively protect equipment and improve operator comfort. They are ideal for automotive, marine, railroad and industrial markets.

Center Bonded Mounts provide flexible suspension systems for mobile transport-



[Request for Quote](#)

[Contact Us](#)

USA
 4392 Broadway
 Depew, NY 14043

Canada
 2290 Industrial Street
 Burlington, Ontario
 L7P 1A1

☎ 888.842.5668

☎ 905.335.5523

✉ info@rpmrubberparts.com



oil-resistant elastomer are available.



[Request for Quote](#)

[Contact Us](#)

 **USA**
4392 Broadway
Depew, NY 14043

 **Canada**
2290 Industrial Street
Burlington, Ontario
L7P 1A1

 888.842.5668

 905.335.5523

 info@rpmrubberparts.com



CB-1120-3 Center Bonded Mounts Cb 1100 Series

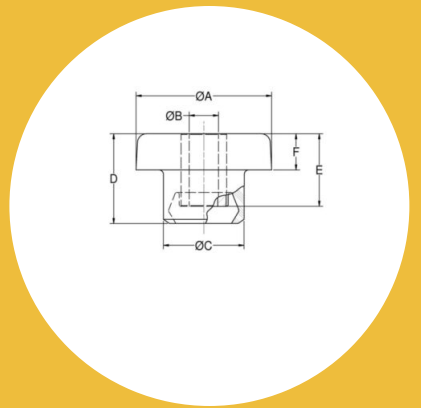

Item # CB-1120-3 Center Bonded Mounts Cb 1100 Series
 Manufacturer: Parker Lord Corporation

Specifications (Continued)

Recommended Bolt Size (in)	3/8
Recommended Steel Washer	(Head Washer J-2049-62)(Tail Washer J-2049-61)
SD (in)	0.75
SD (mm)	19.1
Series	CB-1100
T (in)	0.31
T (mm)	7.9
Thickness (in)	0.125
Thickness (Metric)	3.2

Installation View

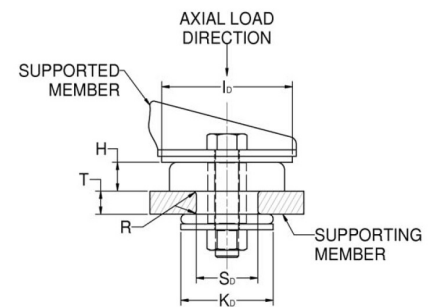

- Center Bonded Mounts isolate vibration, control shock and reduce noise due to structure borne vibrations. Available in a full range of rated load capacities and able to withstand shock loads of 10 g's, these mounts effectively protect equipment and improve operator comfort. They are ideal for automotive, marine, railroad and industrial markets.

Center Bonded Mounts provide flexible suspension systems for mobile transport-



[Request for Quote](#)

[Contact Us](#)

USA
 4392 Broadway
 Depew, NY 14043

Canada
 2290 Industrial Street
 Burlington, Ontario
 L7P 1A1

888.842.5668

905.335.5523

info@rpmrubberparts.com



oil-resistant elastomer are available.



[Request for Quote](#)

[Contact Us](#)

 **USA**
4392 Broadway
Depew, NY 14043

 **Canada**
2290 Industrial Street
Burlington, Ontario
L7P 1A1

 888.842.5668

 905.335.5523

 info@rpmrubberparts.com

