

HYD00-250-70 Hydro Mount



Item # HYD00-250-70 Hydro Mount

Manufacturer: RPM Mechanical

Specifications

Number of Mounting Holes	2
A (mm)	88
B1 (mm)	63
B2 (mm)	73
C (Thread Size)	M10
E (mm)	45
F (mm)	60
G (mm)	30
H (mm)	30
I (mm)	3
J (mm)	56
K (mm)	8.2
Max Load (kg)	70

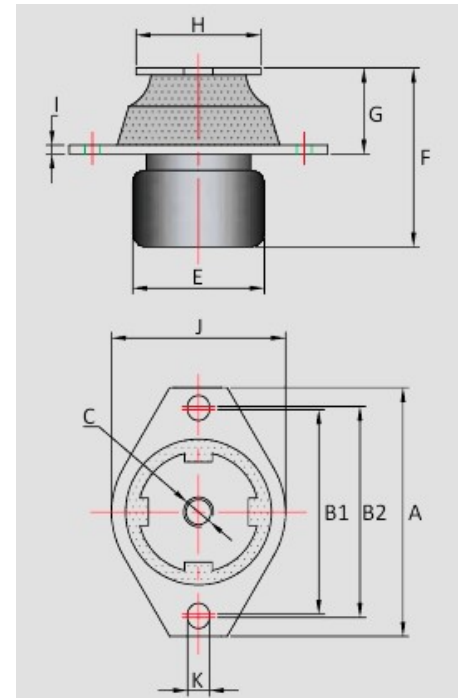

[Request for Quote](#)

[Contact Us](#)

USA
4392 Broadway
Depew, NY 14043

Canada
2290 Industrial Street
Burlington, Ontario
L7P 1A1

888.842.5668

905.335.5523

info@rpmrubberparts.com

