

# HYD01-550-40 Hydro Mount



Item # HYD01-550-40 Hydro Mount

Manufacturer: RPM Mechanical

## Specifications

Number of Mounting Holes	2
A (mm)	132
B1 (mm)	99
B2 (mm)	109
C (Thread Size)	M12
E (mm)	63
F (mm)	96
G (mm)	45
H (mm)	75
I (mm)	5
J (mm)	90
K (mm)	11
Max Load (kg)	125

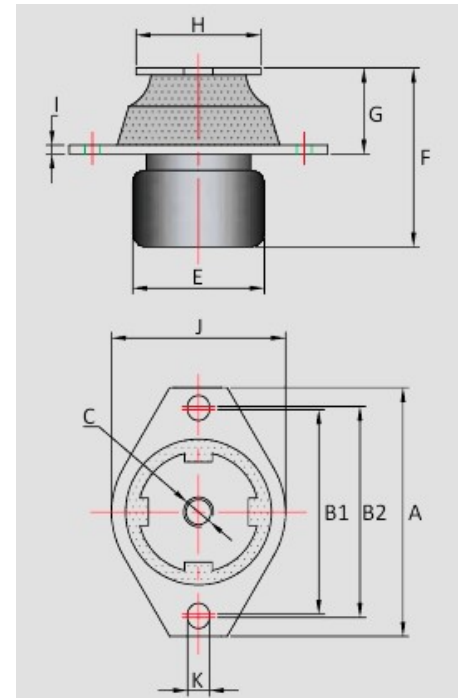

[Request for Quote](#)

[Contact Us](#)

**USA**  
4392 Broadway  
Depew, NY 14043

**Canada**  
2290 Industrial Street  
Burlington, Ontario  
L7P 1A1

888.842.5668

905.335.5523

info@rpmrubberparts.com

