

# HYD03-200-60 Hydro Mount



Item # HYD03-200-60 Hydro Mount

Manufacturer: RPM Mechanical

## Specifications

Number of Mounting Holes	2
A (mm)	175
B1 (mm)	130
B2 (mm)	145
C (Thread Size)	M20
E (mm)	90
F (mm)	115
G (mm)	53
H (mm)	80
I (mm)	8
J (mm)	105
K (mm)	12
Max Load (kg)	350

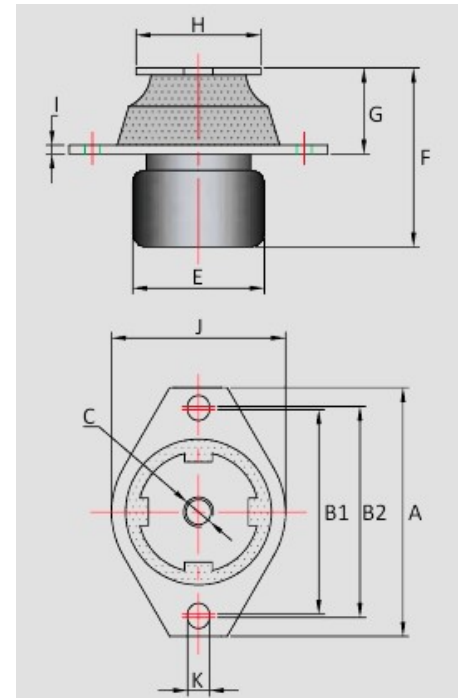

[Request for Quote](#)

[Contact Us](#)

**USA**  
4392 Broadway  
Depew, NY 14043

**Canada**  
2290 Industrial Street  
Burlington, Ontario  
L7P 1A1

888.842.5668

905.335.5523

info@rpmrubberparts.com

