

# HYDSQ01-500-60 Hydro Mount



Item # HYDSQ01-500-60 Hydro Mount  
 Manufacturer: RPM Mechanical

## Specifications

Number of Mounting Holes	4
A (mm)	105
B1 (mm)	64
B2 (mm)	70
L1 (mm)	79.5
L2 (mm)	82.5
C (Thread Size)	M12
E (mm)	63
F (mm)	96
G (mm)	45
H (mm)	60
I (mm)	5
J (mm)	91

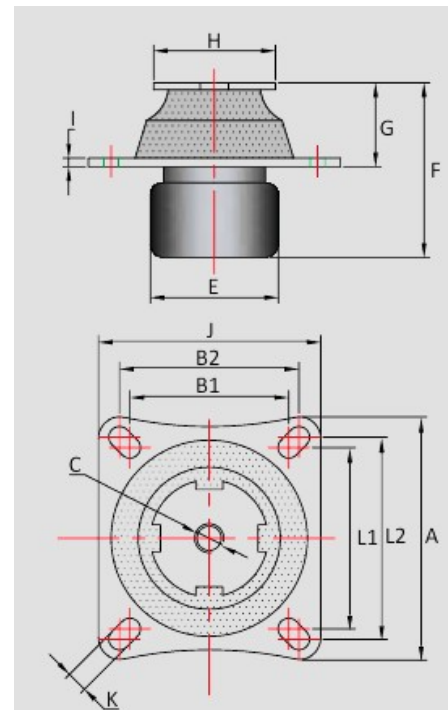

[Request for Quote](#)

[Contact Us](#)

**USA**  
 4392 Broadway  
 Depew, NY 14043

**Canada**  
 2290 Industrial Street  
 Burlington, Ontario  
 L7P 1A1

888.842.5668

905.335.5523

[info@rpmrubberparts.com](mailto:info@rpmrubberparts.com)



# HYDSQ01-500-60 Hydro Mount



Item # HYDSQ01-500-60 Hydro Mount  
Manufacturer: RPM Mechanical

## Specifications (Continued)

K (mm)	10
Max Load (kg)	220

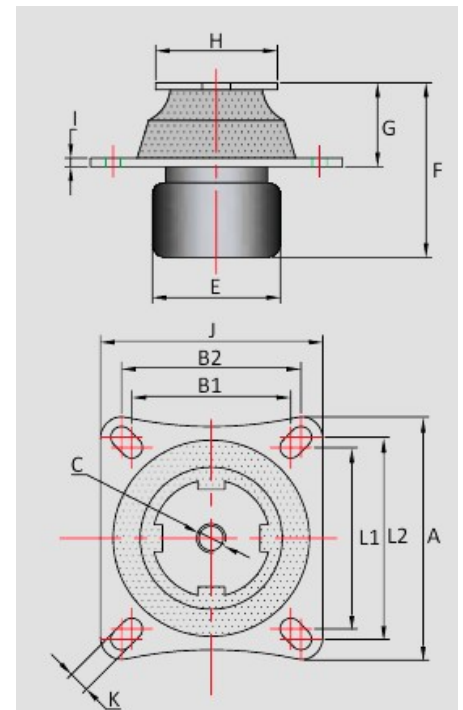

[Request for Quote](#)

[Contact Us](#)

**USA**  
4392 Broadway  
Depew, NY 14043

**Canada**  
2290 Industrial Street  
Burlington, Ontario  
L7P 1A1

888.842.5668

905.335.5523

[info@rpmrubberparts.com](mailto:info@rpmrubberparts.com)

