

HYDSQ01-500-70 Hydro Mount



Item # HYDSQ01-500-70 Hydro Mount
 Manufacturer: RPM Mechanical

Specifications

Number of Mounting Holes	4
A (mm)	105
B1 (mm)	64
B2 (mm)	70
L1 (mm)	79.5
L2 (mm)	82.5
C (Thread Size)	M12
E (mm)	63
F (mm)	96
G (mm)	45
H (mm)	60
I (mm)	5
J (mm)	91

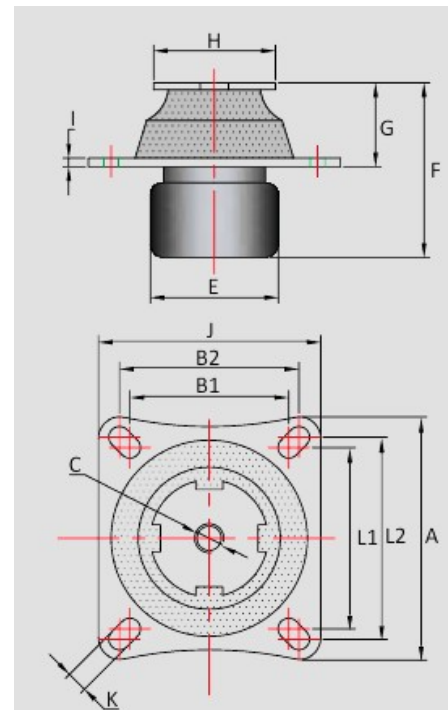

[Request for Quote](#)

[Contact Us](#)

USA
 4392 Broadway
 Depew, NY 14043

Canada
 2290 Industrial Street
 Burlington, Ontario
 L7P 1A1

888.842.5668
 905.335.5523
info@rpmrubberparts.com



HYDSQ01-500-70 Hydro Mount



Item # HYDSQ01-500-70 Hydro Mount
Manufacturer: RPM Mechanical

Specifications (Continued)

K (mm)	10
Max Load (kg)	350

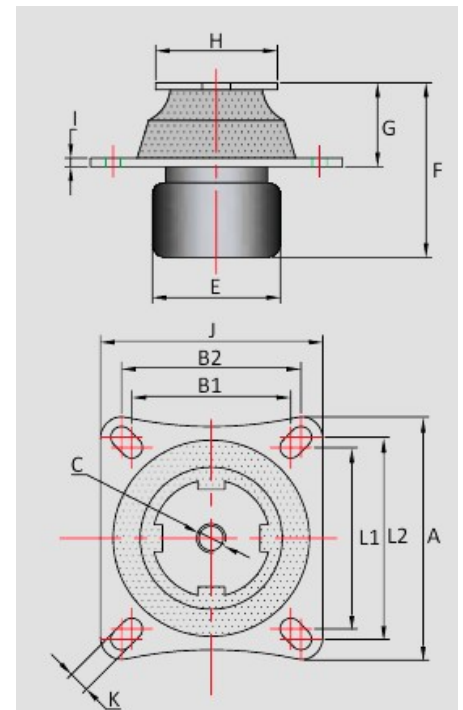

[Request for Quote](#)

[Contact Us](#)

USA
4392 Broadway
Depew, NY 14043

Canada
2290 Industrial Street
Burlington, Ontario
L7P 1A1

888.842.5668

905.335.5523

info@rpmrubberparts.com

