

J-21159-3 Conical Mounts

Item # J-21159-3 Conical Mounts

Manufacturer: Parker Lord Corporation

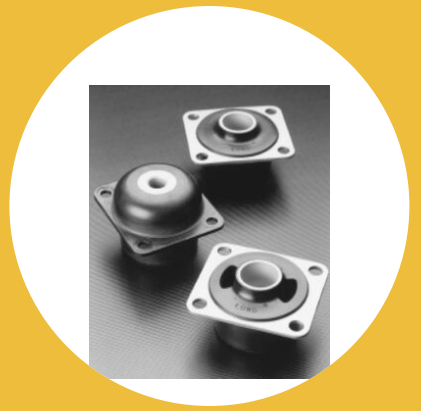

Specifications

Axial Dynamic Stiffness (lbs/in)	4700
Axial Dynamic Stiffness (Metric)	668
Axial Static Stiffness (Imperial)	3812
Axial Static Stiffness (Metric)	668
Manufacturer	Parker LORD
Max Axial Deflection (in)	0.3
Max Axial Deflection (Metric)	7.6
Max Axial Load Rating (lbs)	1200
Max Axial Load Rating (Metric)	5.34
Radial (R?) Static Stiffness (lbs/in)	12970
Radial (R?) Static Stiffness (Metric)	2270
Rated (R?) Static Stiffness (Imperial)	12970
Rated (R?) Static Stiffness (Metric)	2270

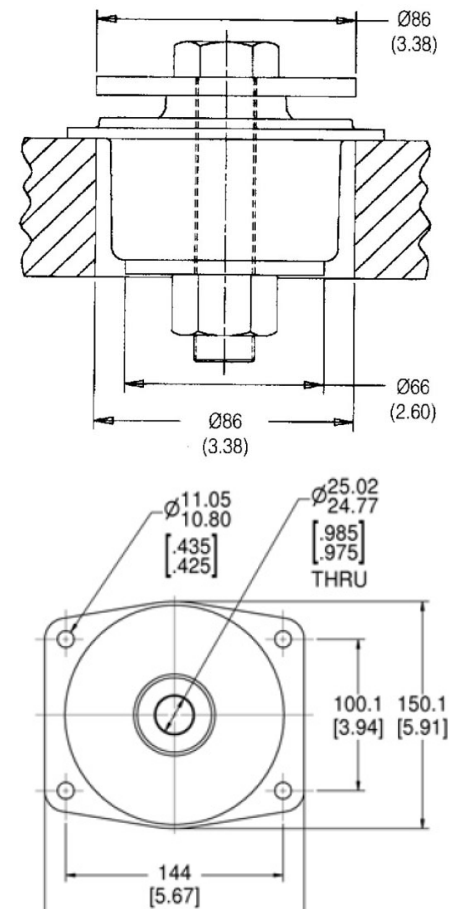

[Request for Quote](#)

[Contact Us](#)

USA
4392 Broadway
Depew, NY 14043

Canada
2290 Industrial Street
Burlington, Ontario
L7P 1A1

888.842.5668
905.335.5523
info@rpmrubberparts.com



J-21159-3 Conical Mounts

Item # J-21159-3 Conical Mounts

Manufacturer: Parker Lord Corporation

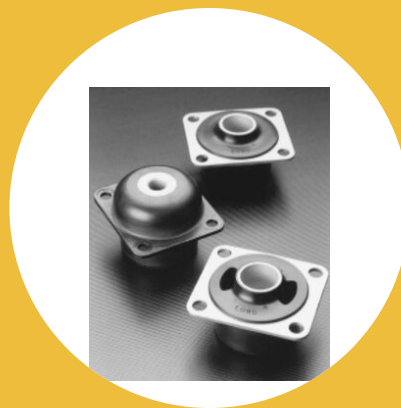

Specifications (Continued)

Rated Axial Static Deflection (in)	0.3
Rated Axial Static Deflection (Metric)	7.6
Rated Axial Static Load (lbs)	1200
Rated Axial Static Load (Metric)	5.34
Recommended Bolt Size (in)	7/8

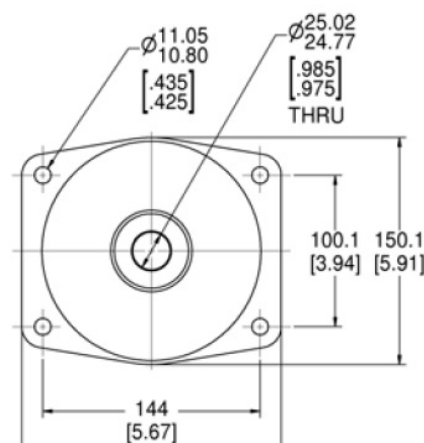
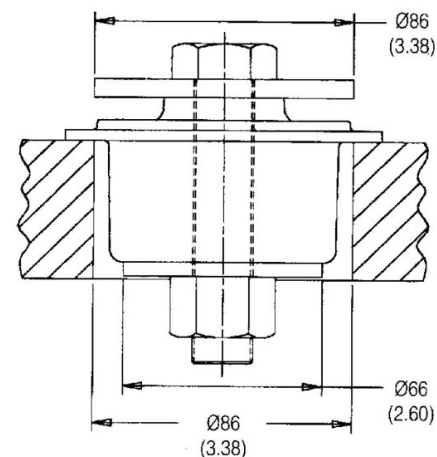

[Request for Quote](#)

[Contact Us](#)

USA
4392 Broadway
Depew, NY 14043

Canada
2290 Industrial Street
Burlington, Ontario
L7P 1A1

888.842.5668
905.335.5523
info@rpmrubberparts.com [in](#) [f](#)