

J-21159-4 Conical Mounts

Item # J-21159-4 Conical Mounts

Manufacturer: Parker Lord Corporation

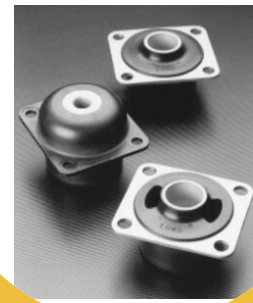

Specifications

| | |
|--|-------------|
| Axial Dynamic Stiffness (lbs/in) | 11600 |
| Axial Dynamic Stiffness (Metric) | 983 |
| Axial Static Stiffness (Imperial) | 5613 |
| Axial Static Stiffness (Metric) | 983 |
| Manufacturer | Parker LORD |
| Max Axial Deflection (in) | 0.3 |
| Max Axial Deflection (Metric) | 7.6 |
| Max Axial Load Rating (lbs) | 2000 |
| Max Axial Load Rating (Metric) | 8.9 |
| Radial (R?) Static Stiffness (lbs/in) | 22140 |
| Radial (R?) Static Stiffness (Metric) | 3877 |
| Rated (R?) Static Stiffness (Imperial) | 22140 |
| Rated (R?) Static Stiffness (Metric) | 3877 |

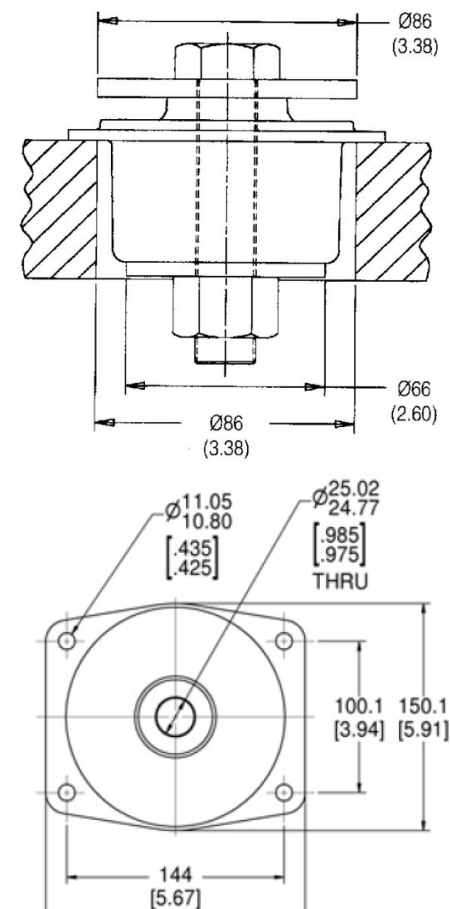

[Request for Quote](#)

[Contact Us](#)

USA
4392 Broadway
Depew, NY 14043

Canada
2290 Industrial Street
Burlington, Ontario
L7P 1A1

888.842.5668

905.335.5523

info@rpmrubberparts.com

J-21159-4 Conical Mounts

Item # J-21159-4 Conical Mounts

Manufacturer: Parker Lord Corporation

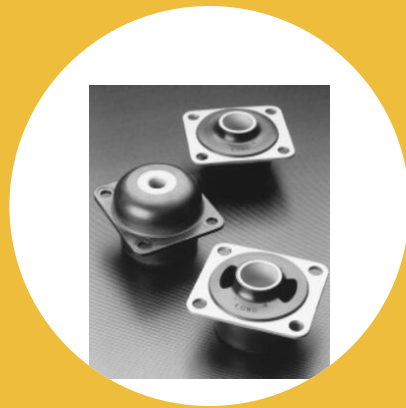

Specifications (Continued)

| | |
|--|------|
| Rated Axial Static Deflection (in) | 0.3 |
| Rated Axial Static Deflection (Metric) | 7.6 |
| Rated Axial Static Load (lbs) | 2000 |
| Rated Axial Static Load (Metric) | 8.9 |
| Recommended Bolt Size (in) | 7/8 |

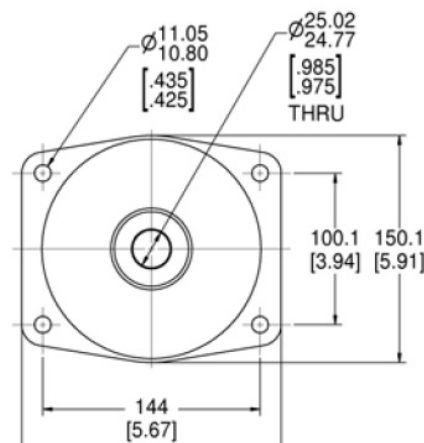
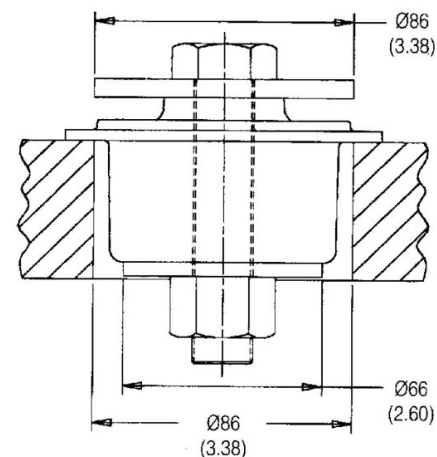

[Request for Quote](#)

[Contact Us](#)

USA
4392 Broadway
Depew, NY 14043

Canada
2290 Industrial Street
Burlington, Ontario
L7P 1A1

888.842.5668

905.335.5523

info@rpmrubberparts.com

