

J-21212-3 Conical Mounts

Item # J-21212-3 Conical Mounts

Manufacturer: Parker Lord Corporation



Specifications

Axial Dynamic Stiffness (lbs/in)	1270
Axial Dynamic Stiffness (Metric)	182
Axial Static Stiffness (Imperial)	1040
Axial Static Stiffness (Metric)	182
Manufacturer	Parker LORD
Max Axial Deflection (in)	0.142
Max Axial Deflection (Metric)	3.6
Max Axial Load Rating (lbs)	180
Max Axial Load Rating (Metric)	800
Radial (R?) Static Stiffness (lbs/in)	2210
Radial (R?) Static Stiffness (Metric)	387
Rated (R?) Static Stiffness (Imperial)	2210
Rated (R?) Static Stiffness (Metric)	387

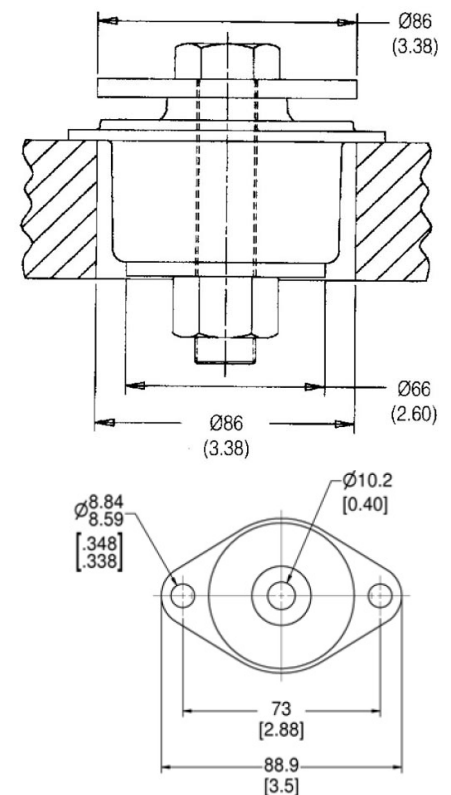

Request for Quote

Contact Us

USA
4392 Broadway
Depew, NY 14043

Canada
2290 Industrial Street
Burlington, Ontario
L7P 1A1

888.842.5668

905.335.5523

info@rpmrubberparts.com



J-21212-3 Conical Mounts

Item # J-21212-3 Conical Mounts

Manufacturer: Parker Lord Corporation

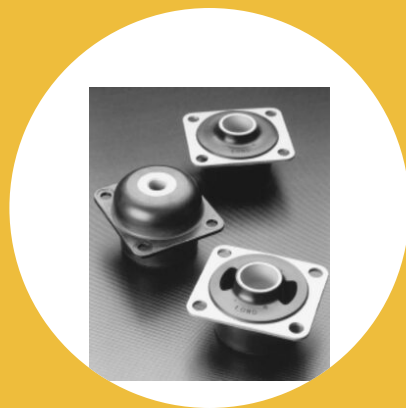

Specifications (Continued)

Rated Axial Static Deflection (in)	0.142
Rated Axial Static Deflection (Metric)	3.6
Rated Axial Static Load (lbs)	180
Rated Axial Static Load (Metric)	800
Recommended Bolt Size (in)	3/8

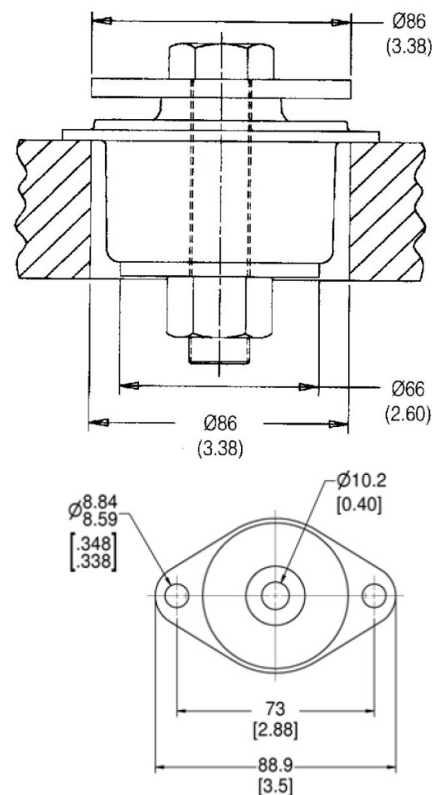

[Request for Quote](#)

[Contact Us](#)

USA
 4392 Broadway
 Depew, NY 14043

Canada
 2290 Industrial Street
 Burlington, Ontario
 L7P 1A1

888.842.5668
 905.335.5523
info@rpmrubberparts.com [in](#) [f](#)