

J-2171-1 Chan-L™ Mount



Item # J-2171-1 Chan-L™ Mount

Manufacturer: Parker Lord Corporation

Specifications

A (in)	2
C (in)	3.69
D (in)	4.5
E (in)	2.75
F (in)	1.56
F (mm)	39.6
Frequency	600
G (in)	0.59
G (mm)	15
Manufacturer	Parker LORD
Max Axial Deflection (in)	0.25
Max Axial Deflection (Metric)	6.4
Max Axial Load Rating (lbs)	100

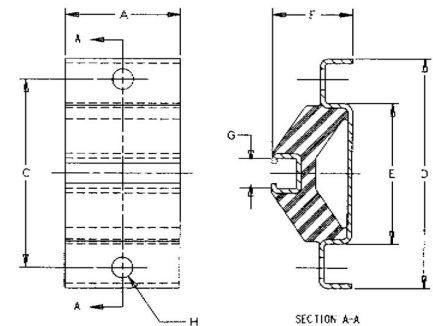

Lord Machinery Mounts are designed to support heavy equipment and isolate intermittent or continuous vibration. The result is greater machine accuracy, longer service life, smoother operation and reduced maintenance. These mounts are available in four types to suit different needs. Chan-L™ Mounts are recommended for machines where vertical disturbing frequencies are 600



[Request for Quote](#)

[Contact Us](#)

USA
4392 Broadway
Depew, NY 14043

Canada
2290 Industrial Street
Burlington, Ontario
L7P 1A1

888.842.5668

905.335.5523

info@rpmrubberparts.com



Provides opening for 3/8" (9.5mm) hex or square head bolt. One hole centered in each side of mount top plate.



[Request for Quote](#)

[Contact Us](#)

 **USA**
4392 Broadway
Depew, NY 14043

 **Canada**
2290 Industrial Street
Burlington, Ontario
L7P 1A1

 888.842.5668

 905.335.5523

 info@rpmrubberparts.com



J-2171-1 Chan-L™ Mount

Item # J-2171-1 Chan-L™ Mount

Manufacturer: Parker Lord Corporation



Specifications (Continued)

Max Axial Load Rating (Metric)	448
Types	II
Weight (lbs/ft)	0.5
Weight (Metric)	0.2

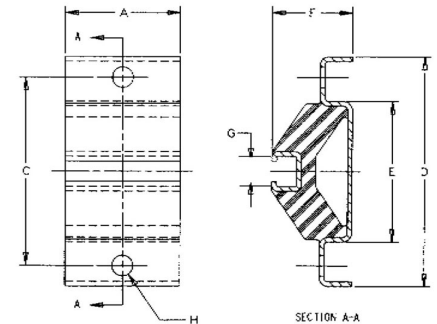

Lord Machinery Mounts are designed to support heavy equipment and isolate intermittent or continuous vibration. The result is greater machine accuracy, longer service life, smoother operation and reduced maintenance. These mounts are available in four types to suit different needs. Chan-L™ Mounts are recommended for machines where vertical disturbing frequencies are 600



[Request for Quote](#)

[Contact Us](#)

USA
4392 Broadway
Depew, NY 14043

Canada
2290 Industrial Street
Burlington, Ontario
L7P 1A1

888.842.5668

905.335.5523

info@rpmrubberparts.com



Provides opening for 3/8" (9.5mm) hex or square head bolt. One hole centered in each side of mount top plate.



[Request for Quote](#)

[Contact Us](#)

 **USA**
4392 Broadway
Depew, NY 14043

 **Canada**
2290 Industrial Street
Burlington, Ontario
L7P 1A1

 888.842.5668

 905.335.5523

 info@rpmrubberparts.com

