

# J-4976-9 Lattice Mount

Item # J-4976-9 Lattice Mount  
 Manufacturer: Lord Corporation



## Specifications

A (in)	12.5
B (in)	10.88
C (in)	8.25
D (in)	2.75
E (in)	5.5
F (in)	3.25
F (mm)	82.6
G (in)	4.56
G (mm)	115.8
J (in)	0.76
J (mm)	19.3
Manufacturer	Parker LORD
Max Axial Deflection (in)	0.62

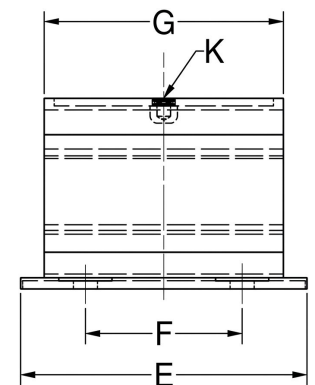
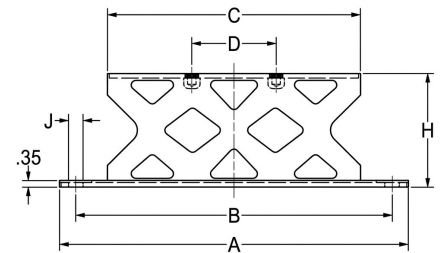

[Request for Quote](#)

[Contact Us](#)

**USA**  
 4392 Broadway  
 Depew, NY 14043

**Canada**  
 2290 Industrial Street  
 Burlington, Ontario  
 L7P 1A1

888.842.5668  
 905.335.5523  
[info@rpmrubberparts.com](mailto:info@rpmrubberparts.com)



# J-4976-9 Lattice Mount

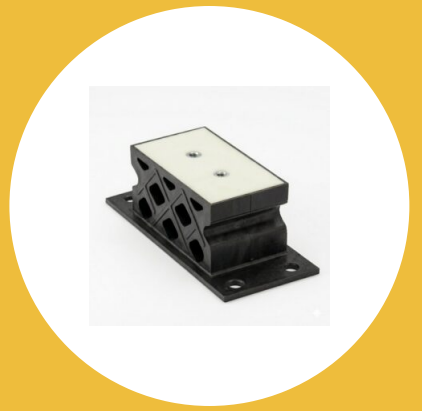

Item # J-4976-9 Lattice Mount

Manufacturer: Lord Corporation

## Specifications (Continued)

Max Axial Deflection (Metric)	15.7
Max Axial Load Rating (lbs)	850
Max Axial Load Rating (Metric)	3781
Types	I
Weight (lbs/ft)	10.6
Weight (Metric)	4.8

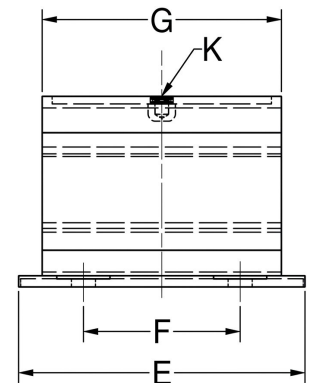
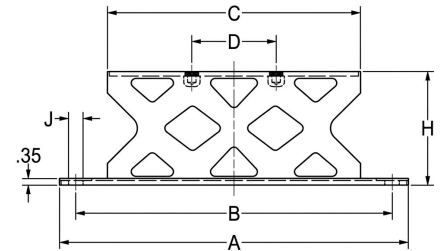

[Request for Quote](#)

[Contact Us](#)

**USA**  
4392 Broadway  
Depew, NY 14043

**Canada**  
2290 Industrial Street  
Burlington, Ontario  
L7P 1A1

888.842.5668

905.335.5523

info@rpmrubberparts.com

