

J-5665-32 Lattice Mount

Item # J-5665-32 Lattice Mount

Manufacturer: Lord Corporation

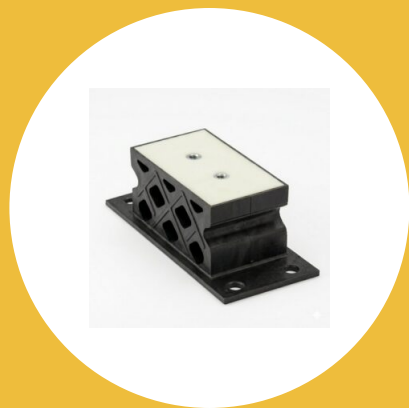

Specifications

| | |
|---------------------------|-------------|
| A (in) | 18.6 |
| B (in) | 16.88 |
| C (in) | 13.5 |
| D (in) | 4.5 |
| E (in) | 9.14 |
| F (in) | 5 |
| F (mm) | 127 |
| G (in) | 7.62 |
| G (mm) | 193.5 |
| J (in) | 0.76 |
| J (mm) | 19.3 |
| Manufacturer | Parker LORD |
| Max Axial Deflection (in) | 1 |

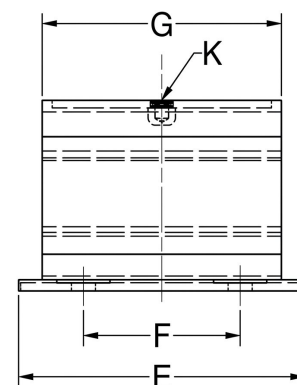
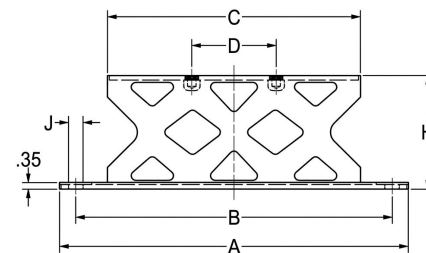

[Request for Quote](#)

[Contact Us](#)

USA
4392 Broadway
Depew, NY 14043

Canada
2290 Industrial Street
Burlington, Ontario
L7P 1A1

888.842.5668

905.335.5523

info@rpmrubberparts.com



J-5665-32 Lattice Mount

Item # J-5665-32 Lattice Mount
 Manufacturer: Lord Corporation



Specifications (Continued)

| | |
|--------------------------------|------|
| Max Axial Deflection (Metric) | 25.4 |
| Max Axial Load Rating (lbs) | 2000 |
| Max Axial Load Rating (Metric) | 8896 |
| Types | I |
| Weight (lbs/ft) | 26.5 |
| Weight (Metric) | 12 |

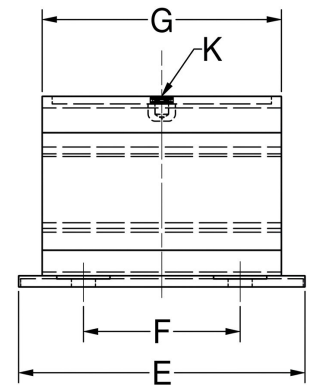
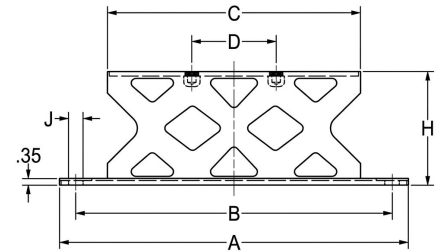

[Request for Quote](#)

[Contact Us](#)

USA
 4392 Broadway
 Depew, NY 14043

Canada
 2290 Industrial Street
 Burlington, Ontario
 L7P 1A1

888.842.5668
 905.335.5523
 info@rpmrubberparts.com

