

J-8203-35 Square Bonded Bushings



Item # J-8203-35 Square Bonded Bushings
Manufacturer: Parker Lord Corporation

Specifications

A (in)	2.4
B (in)	3.25
C (in)	1.379
D (in)	1.62
E (in)	2.15
F (in)	2.25
F (mm)	57.2
G (in)	3
G (mm)	76.2
I (in)	1.442
I (mm)	36.7
J (in)	0.09
J (mm)	2.3

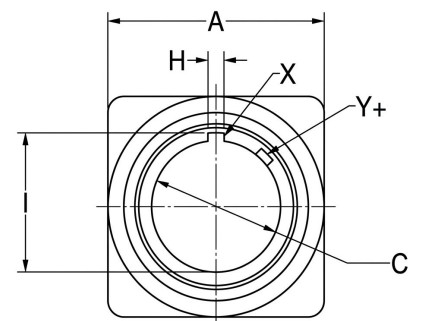

+Y - KEY LOCATION 45° FROM VERTICAL

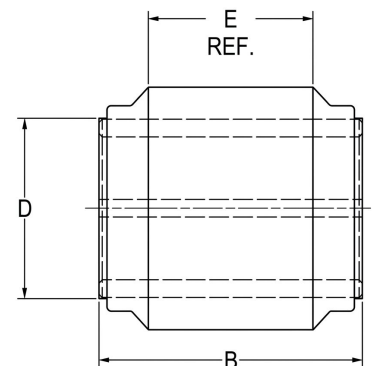

[Request for Quote](#)

[Contact Us](#)

USA
 4392 Broadway
 Depew, NY 14043

Canada
 2290 Industrial Street
 Burlington, Ontario
 L7P 1A1

888.842.5668
 905.335.5523
info@rpmrubberparts.com



J-8203-35 Square Bonded Bushings



Item # J-8203-35 Square Bonded Bushings
Manufacturer: Parker Lord Corporation

Specifications (Continued)

Key Location	Y
Max Radial Static Load Rating (lbs)	1700
Max Radial Static Load Rating (kg)	7562
Spring Rate Radial K?R??? (lbs/in)	100000
Spring Rate Radial K?R??? (N/m)	17510
Static Torque (lb-ft)	2400
Static Torque (Nm)	3252

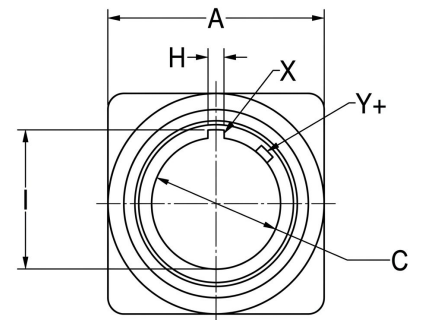

+Y - KEY LOCATION 45° FROM VERTICAL

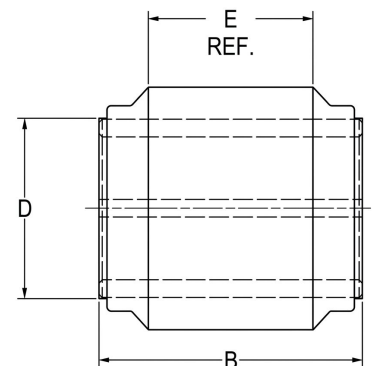

[Request for Quote](#)

[Contact Us](#)

USA
 4392 Broadway
 Depew, NY 14043

Canada
 2290 Industrial Street
 Burlington, Ontario
 L7P 1A1

888.842.5668

905.335.5523

info@rpmrubberparts.com

