

SMB006-0500-6 Sandwich Mounts Metric Thread Type 2



Item # SMB006-0500-6 Sandwich Mounts Metric Thread Type 2

Manufacturer: LORD Corporation

Specifications

A (in)	0.62
B (in)	1/4
C (in)	0.62
Compression Spring Rate Kc (Imperial)	52
Compression Spring Rate Kc (Metric)	96
Compression Static Load (lbs)	17
Compression Static Load (Metric)	76
D (in)	0.5
Durometer	37
Elastomer	Oil Resistant Elastomer - Neoprene
Grade per SAE J429	4.6
Manufacturer	Parker LORD
Shear Spring Rate Ks (lbs/in)	110

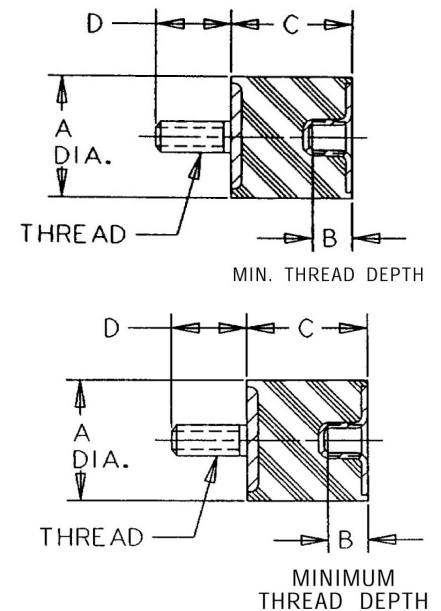

Request for Quote

Contact Us

USA
4392 Broadway
Depew, NY 14043

Canada
2290 Industrial Street
Burlington, Ontario
L7P 1A1

888.842.5668

905.335.5523

info@rpmrubberparts.com



SMB006-0500-6 Sandwich Mounts Metric Thread Type 2



Item # SMB006-0500-6 Sandwich Mounts Metric Thread Type 2
 Manufacturer: LORD Corporation

Specifications (Continued)

Shear Spring Rate Ks (Metric)	19
Shear Static Load (lbs)	4
Shear Static Load (Metric)	18
Thread Size	M6
Thread Type	Metric
Types	2



[Request for Quote](#)

[Contact Us](#)

USA
 4392 Broadway
 Depew, NY 14043

Canada
 2290 Industrial Street
 Burlington, Ontario
 L7P 1A1

888.842.5668
 905.335.5523
info@rpmrubberparts.com

