

SSB33-1001-4 Two-Piece Mounts Ssb Series



Item # SSB33-1001-4 Two-Piece Mounts Ssb Series
 Manufacturer: Lord Corporation

Specifications

A (in)	3.24
Axial Static Spring Rate (lbs/in)	37500
Axial Static Spring Rate (Metric)	6566
B (in)	3.21
C (in)	0.81
D (in)	0.125
E (in)	1.81
F (in)	1.84
I (in)	0.765
I (mm)	19.4
K (in)	2.06
K (mm)	52.3
Manufacturer	Parker LORD

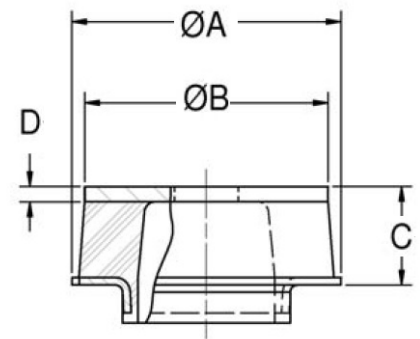

Two-Piece Mounts are designed for applications involving severe dynamic forces in the static load direction, as well as the rebound direction. Travel is limited in both directions by rubber in compression which provides snubbing. These mounts are designed to support engines, cabs and accessory units, accommodate

[Request for Quote](#)
[Contact Us](#)

USA
 4392 Broadway
 Depew, NY 14043

Canada
 2290 Industrial Street
 Burlington, Ontario
 L7P 1A1

☎ 888.842.5668

☎ 905.335.5523

✉ info@rpmrubberparts.com



uses. For off-highway, use
80% of the load shown.



[Request for Quote](#)

[Contact Us](#)

 **USA**
4392 Broadway
Depew, NY 14043

 **Canada**
2290 Industrial Street
Burlington, Ontario
L7P 1A1

 888.842.5668

 905.335.5523

 info@rpmrubberparts.com



SSB33-1001-4 Two-Piece Mounts Ssb Series



Item # SSB33-1001-4 Two-Piece Mounts Ssb Series
 Manufacturer: Lord Corporation

Specifications (Continued)

Material	Low Carbon Steel
Max Axial Static Load at Deflection (lbs)	1125 at 0.03
Max Axial Static Load Rating at Deflection (lbs/in)	1125 at 0.03
Radial Static Spring Rate (lbs/in)	3890
Radial Static Spring Rate (Metric)	3890
Recommended Bolt Grade or Class (SAE J1199)	10.9
Recommended Bolt Grade or Class (SAE J429)	8
Recommended Bolt Size (in)	3/4
SD (in)	1.87
SD (mm)	47.6
Series	Armored Series
T (in)	0.625
T (mm)	15.9

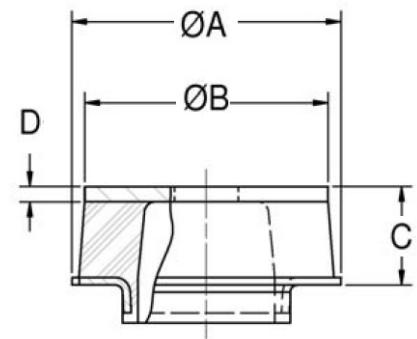

Two-Piece Mounts are designed for applications involving severe dynamic forces in the static load direction, as well as the rebound direction. Travel is limited in both directions by rubber in compression which provides snubbing. These mounts are designed to support engines, cabs and accessory units, accommodate

[Request for Quote](#)
[Contact Us](#)

USA
 4392 Broadway
 Depew, NY 14043

Canada
 2290 Industrial Street
 Burlington, Ontario
 L7P 1A1

☎ 888.842.5668

☎ 905.335.5523

✉ info@rpmrubberparts.com



uses. For off-highway, use
80% of the load shown.



[Request for Quote](#)

[Contact Us](#)

 **USA**
4392 Broadway
Depew, NY 14043

 **Canada**
2290 Industrial Street
Burlington, Ontario
L7P 1A1

 888.842.5668

 905.335.5523

 info@rpmrubberparts.com



SSB33-1001-4 Two-Piece Mounts Ssb Series



Item # SSB33-1001-4 Two-Piece Mounts Ssb Series
 Manufacturer: Lord Corporation

Specifications (Continued)

Types	Mtg.
-------	------

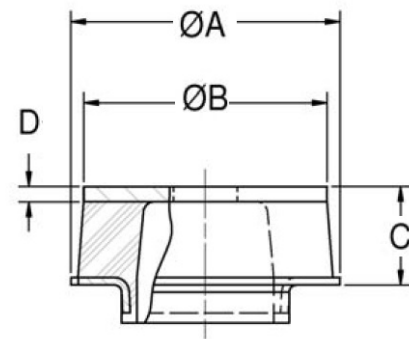

Two-Piece Mounts are designed for applications involving severe dynamic forces in the static load direction, as well as the rebound direction. Travel is limited in both directions by rubber in compression which provides snubbing. These mounts are designed to support engines, cabs and accessory units, accommodate



[Request for Quote](#)

[Contact Us](#)

USA
 4392 Broadway
 Depew, NY 14043

Canada
 2290 Industrial Street
 Burlington, Ontario
 L7P 1A1

888.842.5668

905.335.5523

info@rpmrubberparts.com



uses. For off-highway, use
80% of the load shown.



[Request for Quote](#)

[Contact Us](#)

 **USA**
4392 Broadway
Depew, NY 14043

 **Canada**
2290 Industrial Street
Burlington, Ontario
L7P 1A1

 888.842.5668

 905.335.5523

 info@rpmrubberparts.com

