

VMB-2020L Sandwich Mounts Metric Thread Type 2



Item # VMB-2020L Sandwich Mounts Metric Thread Type 2
Manufacturer: RPM Mechanical Inc

Specifications

A (in)	0.79
B (in)	0.24
C (in)	0.79
Compression Spring Rate Kc (Imperial)	38
Compression Spring Rate Kc (Metric)	215
Compression Static Load (lbs)	86
Compression Static Load (Metric)	386
D (in)	0.63
Durometer	68
Elastomer	Natural Rubber
Grade per SAE J429	4.6
Manufacturer	RPM Mechanical Inc.
Shear Spring Rate Ks (lbs/in)	8

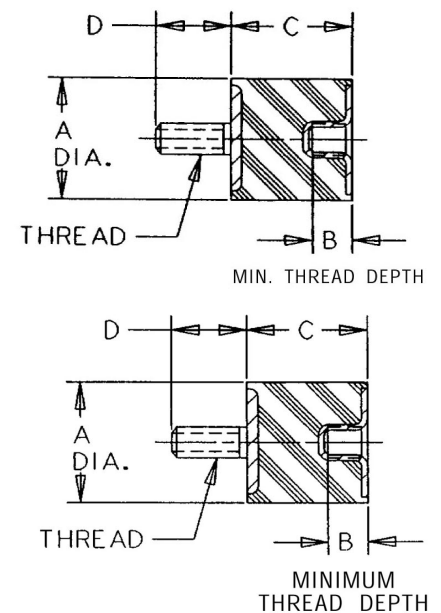
[Request for Quote](#)
[Contact Us](#)

USA
4392 Broadway
Depew, NY 14043

Canada
2290 Industrial Street
Burlington, Ontario
L7P 1A1

888.842.5668

905.335.5523

info@rpmrubberparts.com



VMB-2020L Sandwich Mounts Metric Thread Type 2



Item # VMB-2020L Sandwich Mounts Metric Thread Type 2
Manufacturer: RPM Mechanical Inc

Specifications (Continued)

Shear Spring Rate Ks (Metric)	45
Shear Static Load (lbs)	28
Shear Static Load (Metric)	129
Thread Size	M6
Thread Type	Metric
Types	2



[Request for Quote](#)

[Contact Us](#)

USA
4392 Broadway
Depew, NY 14043

Canada
2290 Industrial Street
Burlington, Ontario
L7P 1A1

888.842.5668

905.335.5523

info@rpmrubberparts.com

