

VMB-4050B Sandwich Mounts Metric Thread Type 2



Item # VMB-4050B Sandwich Mounts Metric Thread Type 2

Manufacturer: RPM Mechanical Inc

Specifications

A (in)	1.57
B (in)	0.31
C (in)	2
Compression Spring Rate Kc (Imperial)	20
Compression Spring Rate Kc (Metric)	117
Compression Static Load (lbs)	172
Compression Static Load (Metric)	767
D (in)	0.91
Durometer	57
Elastomer	Natural Rubber
Grade per SAE J429	4.6
Manufacturer	RPM Mechanical Inc.
Shear Spring Rate Ks (lbs/in)	5.4

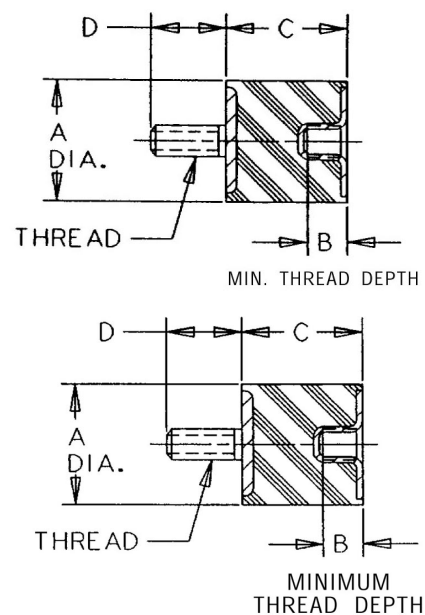

[Request for Quote](#)

[Contact Us](#)

USA
4392 Broadway
Depew, NY 14043

Canada
2290 Industrial Street
Burlington, Ontario
L7P 1A1

888.842.5668

905.335.5523

info@rpmrubberparts.com



VMB-4050B Sandwich Mounts Metric Thread Type 2



Item # VMB-4050B Sandwich Mounts Metric Thread Type 2
Manufacturer: RPM Mechanical Inc

Specifications (Continued)

Shear Spring Rate Ks (Metric)	31
Shear Static Load (lbs)	57
Shear Static Load (Metric)	256
Thread Size	M8
Thread Type	Metric
Types	2



[Request for Quote](#)

[Contact Us](#)

USA
4392 Broadway
Depew, NY 14043

Canada
2290 Industrial Street
Burlington, Ontario
L7P 1A1

888.842.5668

905.335.5523

info@rpmrubberparts.com

