

VMB-4050H Sandwich Mounts Metric Thread Type 2



Item # VMB-4050H Sandwich Mounts Metric Thread Type 2
Manufacturer: RPM Mechanical Inc

Specifications

A (in)	1.57
B (in)	0.31
C (in)	2
Compression Spring Rate Kc (Imperial)	11
Compression Spring Rate Kc (Metric)	63
Compression Static Load (lbs)	93
Compression Static Load (Metric)	414
D (in)	0.91
Durometer	43
Elastomer	Natural Rubber
Grade per SAE J429	4.6
Manufacturer	RPM Mechanical Inc.
Shear Spring Rate Ks (lbs/in)	2.9

[Request for Quote](#)
[Contact Us](#)

USA
4392 Broadway
Depew, NY 14043

Canada
2290 Industrial Street
Burlington, Ontario
L7P 1A1

888.842.5668

905.335.5523

info@rpmrubberparts.com



VMB-4050H Sandwich Mounts Metric Thread Type 2



Item # VMB-4050H Sandwich Mounts Metric Thread Type 2
Manufacturer: RPM Mechanical Inc

Specifications (Continued)

Shear Spring Rate Ks (Metric)	16
Shear Static Load (lbs)	31
Shear Static Load (Metric)	138
Thread Size	M8
Thread Type	Metric
Types	2

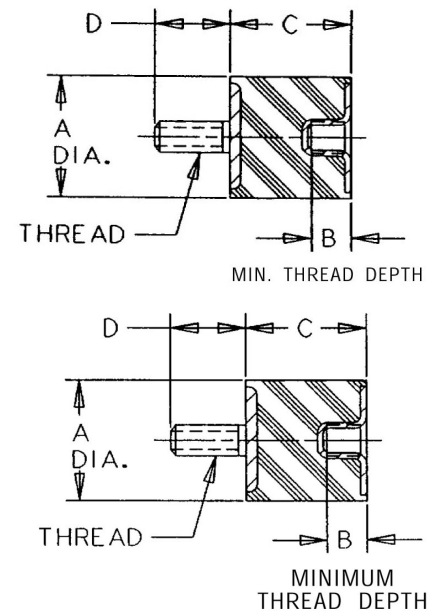

[Request for Quote](#)

[Contact Us](#)

USA
 4392 Broadway
 Depew, NY 14043

Canada
 2290 Industrial Street
 Burlington, Ontario
 L7P 1A1

☎ 888.842.5668

☎ 905.335.5523

✉ info@rpmrubberparts.com

