

VMB-7540B Sandwich Mounts Metric Thread Type 2



Item # VMB-7540B Sandwich Mounts Metric Thread Type 2
Manufacturer: RPM Mechanical Inc

Specifications

A (in)	3
B (in)	0.47
C (in)	1.57
Compression Spring Rate Kc (Imperial)	162
Compression Spring Rate Kc (Metric)	916
Compression Static Load (lbs)	942
Compression Static Load (Metric)	4190
D (in)	1.46
Durometer	57
Elastomer	Natural Rubber
Grade per SAE J429	4.6
Manufacturer	RPM Mechanical Inc.
Shear Spring Rate Ks (lbs/in)	27

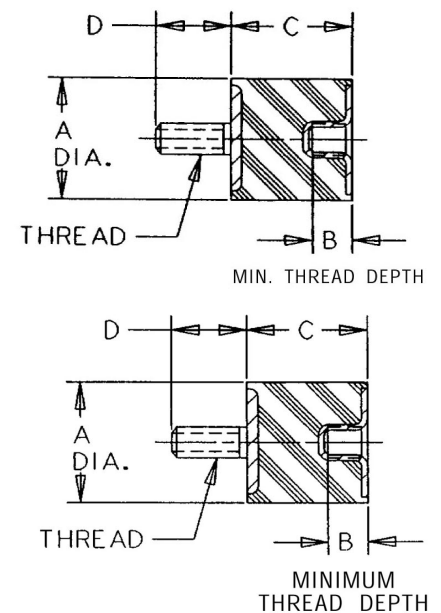
[Request for Quote](#)
[Contact Us](#)

USA
4392 Broadway
Depew, NY 14043

Canada
2290 Industrial Street
Burlington, Ontario
L7P 1A1

888.842.5668

905.335.5523

info@rpmrubberparts.com



VMB-7540B Sandwich Mounts Metric Thread Type 2



Item # VMB-7540B Sandwich Mounts Metric Thread Type 2
Manufacturer: RPM Mechanical Inc

Specifications (Continued)

Shear Spring Rate Ks (Metric)	153
Shear Static Load (lbs)	314
Shear Static Load (Metric)	1397
Thread Size	M12
Thread Type	Metric
Types	2



[Request for Quote](#)

[Contact Us](#)

USA
4392 Broadway
Depew, NY 14043

Canada
2290 Industrial Street
Burlington, Ontario
L7P 1A1

888.842.5668

905.335.5523

info@rpmrubberparts.com

