

# VMB-7555B Sandwich Mounts Metric Thread Type 2



**Item #** VMB-7555B Sandwich Mounts Metric Thread Type 2  
**Manufacturer:** RPM Mechanical Inc

## Specifications

A (in)	3
B (in)	0.47
C (in)	2.16
Compression Spring Rate Kc (Imperial)	86
Compression Spring Rate Kc (Metric)	487
Compression Static Load (lbs)	747
Compression Static Load (Metric)	3325
D (in)	1.46
Durometer	57
Elastomer	Natural Rubber
Grade per SAE J429	4.6
Manufacturer	RPM Mechanical Inc.
Shear Spring Rate Ks (lbs/in)	18

[Request for Quote](#)
[Contact Us](#)

**USA**  
4392 Broadway  
Depew, NY 14043

**Canada**  
2290 Industrial Street  
Burlington, Ontario  
L7P 1A1

888.842.5668

905.335.5523

[info@rpmrubberparts.com](mailto:info@rpmrubberparts.com)

# VMB-7555B Sandwich Mounts Metric Thread Type 2



**Item #** VMB-7555B Sandwich Mounts Metric Thread Type 2  
**Manufacturer:** RPM Mechanical Inc

## Specifications (Continued)

Shear Spring Rate Ks (Metric)	103
Shear Static Load (lbs)	249
Shear Static Load (Metric)	1108
Thread Size	M12
Thread Type	Metric
Types	2

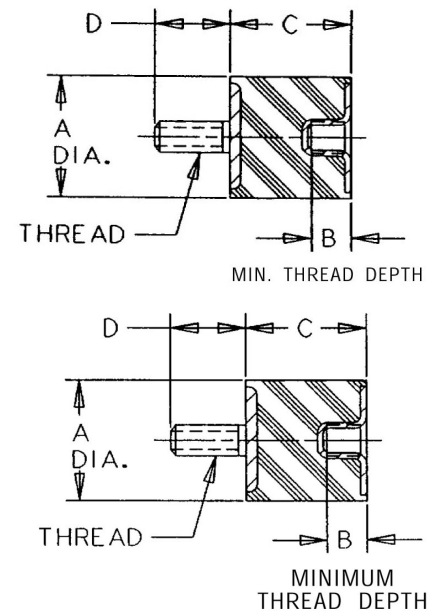

[Request for Quote](#)

[Contact Us](#)

**USA**  
 4392 Broadway  
 Depew, NY 14043

**Canada**  
 2290 Industrial Street  
 Burlington, Ontario  
 L7P 1A1

☎ 888.842.5668

☎ 905.335.5523

✉ [info@rpmrubberparts.com](mailto:info@rpmrubberparts.com)

