

VMC-1315C Sandwich Mounts Metric Thread Type 4



Item # VMC-1315C Sandwich Mounts Metric Thread Type 4
Manufacturer: RPM Mechanical

Specifications

A (in)	0.5
B (in)	0.16
C (in)	0.59
Compression Spring Rate Kc (Imperial)	32
Compression Spring Rate Kc (Metric)	72
Compression Static Load (lbs)	21
Compression Static Load (Metric)	95
D (in)	0.16
Durometer	57
Elastomer	Natural Rubber
Manufacturer	
Shear Spring Rate Ks (lbs/in)	3
Shear Spring Rate Ks (Metric)	16

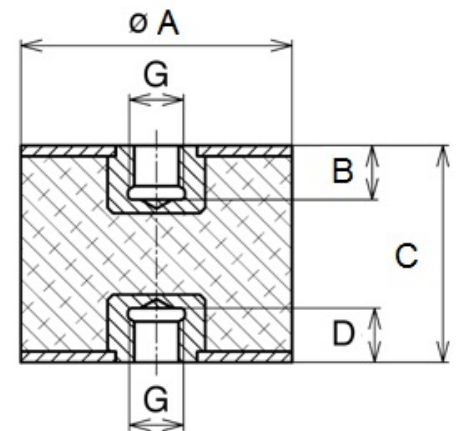
[Request for Quote](#)
[Contact Us](#)

USA
4392 Broadway
Depew, NY 14043

Canada
2290 Industrial Street
Burlington, Ontario
L7P 1A1

888.842.5668

905.335.5523

info@rpmrubberparts.com



VMC-1315C Sandwich Mounts Metric Thread Type 4



Item # VMC-1315C Sandwich Mounts Metric Thread Type 4
Manufacturer: RPM Mechanical

Specifications (Continued)

Shear Static Load (lbs)	7
Shear Static Load (Metric)	32
Thread Size	M4
Types	4

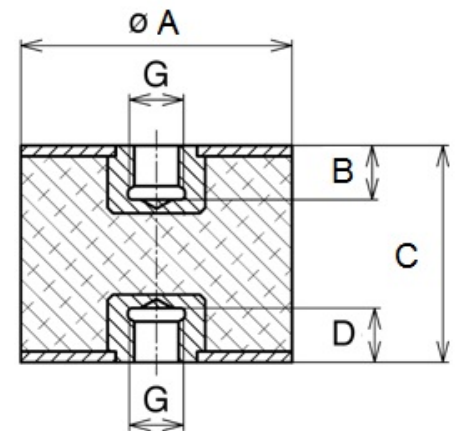

[Request for Quote](#)

[Contact Us](#)

USA
4392 Broadway
Depew, NY 14043

Canada
2290 Industrial Street
Burlington, Ontario
L7P 1A1

888.842.5668

905.335.5523

info@rpmrubberparts.com

