

VMC-1515C Sandwich Mounts Metric Thread Type 4



Item # VMC-1515C Sandwich Mounts Metric Thread Type 4
Manufacturer: RPM Mechanical

Specifications

A (in)	0.59
B (in)	0.16
C (in)	0.59
Compression Spring Rate Kc (Imperial)	46
Compression Spring Rate Kc (Metric)	259
Compression Static Load (lbs)	44
Compression Static Load (Metric)	194
D (in)	0.16
Durometer	57
Elastomer	Natural Rubber
Manufacturer	
Shear Spring Rate Ks (lbs/in)	7
Shear Spring Rate Ks (Metric)	37

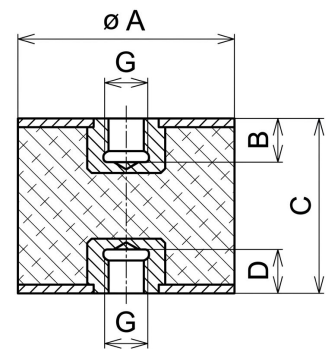
[Request for Quote](#)
[Contact Us](#)

USA
4392 Broadway
Depew, NY 14043

Canada
2290 Industrial Street
Burlington, Ontario
L7P 1A1

888.842.5668

905.335.5523

info@rpmrubberparts.com

VMC-1515C Sandwich Mounts Metric Thread Type 4



Item # VMC-1515C Sandwich Mounts Metric Thread Type 4
Manufacturer: RPM Mechanical

Specifications (Continued)

Shear Static Load (lbs)	15
Shear Static Load (Metric)	65
Thread Size	M4
Types	4

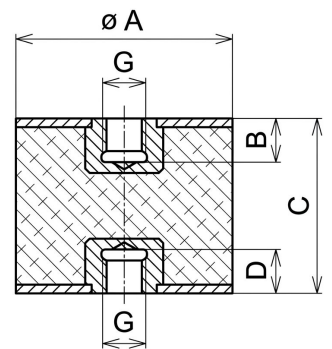

[Request for Quote](#)

[Contact Us](#)

USA
4392 Broadway
Depew, NY 14043

Canada
2290 Industrial Street
Burlington, Ontario
L7P 1A1

888.842.5668

905.335.5523

info@rpmrubberparts.com

