

# VMC-2535I Sandwich Mounts Metric Thread Type 4



**Item #** VMC-2535I Sandwich Mounts Metric Thread Type 4  
**Manufacturer:** RPM Mechanical

## Specifications

A (in)	1
B (in)	0.24
C (in)	1.38
Compression Spring Rate Kc (Imperial)	7
Compression Spring Rate Kc (Metric)	39
Compression Static Load (lbs)	36
Compression Static Load (Metric)	161
D (in)	0.24
Durometer	43
Elastomer	Natural Rubber
Manufacturer	
Shear Spring Rate Ks (lbs/in)	2
Shear Spring Rate Ks (Metric)	10

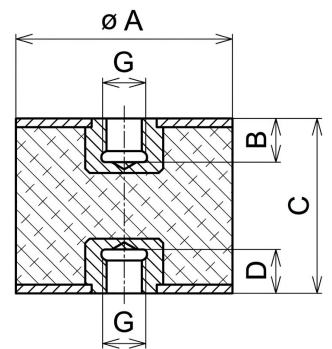
[Request for Quote](#)
[Contact Us](#)

**USA**  
4392 Broadway  
Depew, NY 14043

**Canada**  
2290 Industrial Street  
Burlington, Ontario  
L7P 1A1

888.842.5668

905.335.5523

[info@rpmrubberparts.com](mailto:info@rpmrubberparts.com)



# VMC-2535I Sandwich Mounts Metric Thread Type 4

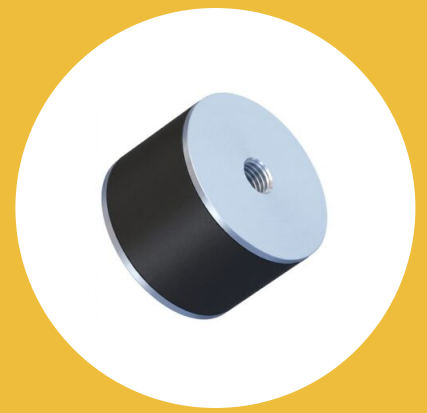

Item # VMC-2535I Sandwich Mounts Metric Thread Type 4  
Manufacturer: RPM Mechanical

## Specifications (Continued)

Shear Static Load (lbs)	12
Shear Static Load (Metric)	54
Thread Size	M6
Types	4

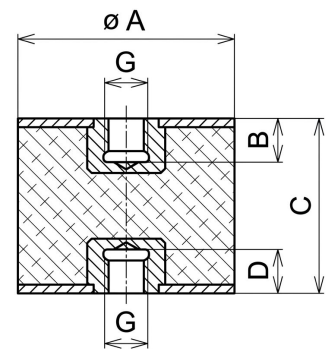

[Request for Quote](#)

[Contact Us](#)

**USA**  
4392 Broadway  
Depew, NY 14043

**Canada**  
2290 Industrial Street  
Burlington, Ontario  
L7P 1A1

888.842.5668

905.335.5523

[info@rpmrubberparts.com](mailto:info@rpmrubberparts.com)

