

VMC-6060C Sandwich Mounts Metric Thread Type 4



Item # VMC-6060C Sandwich Mounts Metric Thread Type 4
Manufacturer: RPM Mechanical

Specifications

A (in)	2.35
B (in)	0.39
C (in)	2.35
Compression Spring Rate Kc (Imperial)	47
Compression Spring Rate Kc (Metric)	268
Compression Static Load (lbs)	428
Compression Static Load (Metric)	1905
D (in)	0.39
Durometer	57
Elastomer	Natural Rubber
Manufacturer	
Shear Spring Rate Ks (lbs/in)	11
Shear Spring Rate Ks (Metric)	63

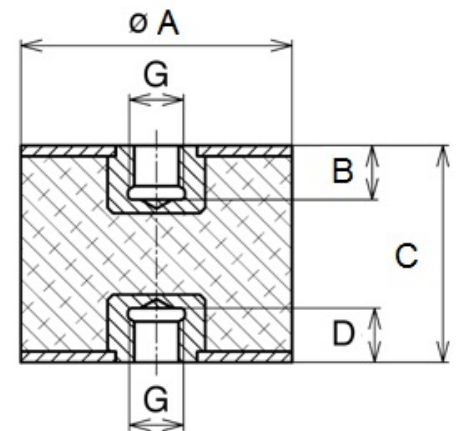

[Request for Quote](#)

[Contact Us](#)

USA
4392 Broadway
Depew, NY 14043

Canada
2290 Industrial Street
Burlington, Ontario
L7P 1A1

888.842.5668

905.335.5523

info@rpmrubberparts.com



VMC-6060C Sandwich Mounts Metric Thread Type 4



Item # VMC-6060C Sandwich Mounts Metric Thread Type 4
Manufacturer: RPM Mechanical

Specifications (Continued)

Shear Static Load (lbs)	143
Shear Static Load (Metric)	1907
Thread Size	M10
Types	4

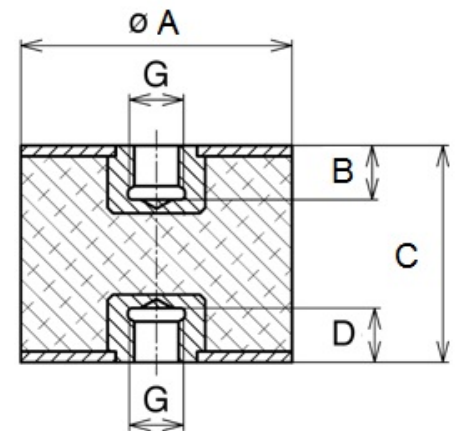

[Request for Quote](#)

[Contact Us](#)

USA
4392 Broadway
Depew, NY 14043

Canada
2290 Industrial Street
Burlington, Ontario
L7P 1A1

888.842.5668

905.335.5523

info@rpmrubberparts.com

