

# VMC-7555I Sandwich Mounts Metric Thread Type 4



**Item #** VMC-7555I Sandwich Mounts Metric Thread Type 4  
**Manufacturer:** RPM Mechanical

## Specifications

A (in)	3
B (in)	0.47
C (in)	2.17
Compression Spring Rate Kc (Imperial)	53
Compression Spring Rate Kc (Metric)	297
Compression Static Load (lbs)	420
Compression Static Load (Metric)	1869
D (in)	0.47
Durometer	43
Elastomer	Natural Rubber
Manufacturer	
Shear Spring Rate Ks (lbs/in)	11
Shear Spring Rate Ks (Metric)	60

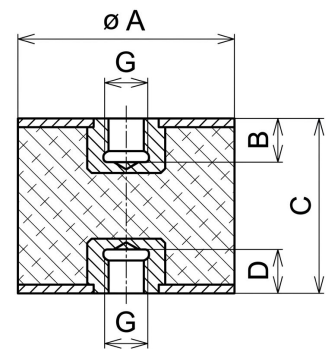
[Request for Quote](#)
[Contact Us](#)

**USA**  
4392 Broadway  
Depew, NY 14043

**Canada**  
2290 Industrial Street  
Burlington, Ontario  
L7P 1A1

888.842.5668

905.335.5523

[info@rpmrubberparts.com](mailto:info@rpmrubberparts.com)



# VMC-7555I Sandwich Mounts Metric Thread Type 4

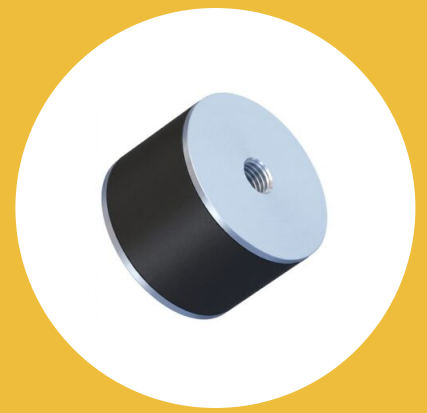

Item # VMC-7555I Sandwich Mounts Metric Thread Type 4  
Manufacturer: RPM Mechanical

## Specifications (Continued)

Shear Static Load (lbs)	140
Shear Static Load (Metric)	623
Thread Size	M12
Types	4

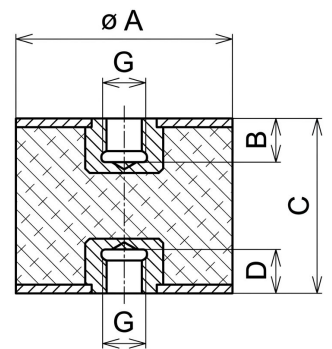

[Request for Quote](#)

[Contact Us](#)

**USA**  
4392 Broadway  
Depew, NY 14043

**Canada**  
2290 Industrial Street  
Burlington, Ontario  
L7P 1A1

888.842.5668

905.335.5523

[info@rpmrubberparts.com](mailto:info@rpmrubberparts.com)

