

# VMS-1609-45-M16 Marine Mount



Item # VMS-1609-45-M16 Marine Mount

## Specifications

A (mm)	183
B (mm)	50
C (mm)	75
D (mm)	140
F (mm)	13
G (mm)	30
J (mm)	20
M (mm)	M16
S (mm)	4
Max Load (kg)	150

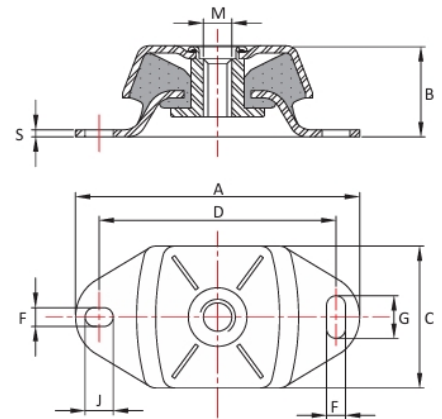

[Request for Quote](#)

[Contact Us](#)

**USA**  
4392 Broadway  
Depew, NY 14043

**Canada**  
2290 Industrial Street  
Burlington, Ontario  
L7P 1A1

☎ 888.842.5668

☎ 905.335.5523

✉ [info@rpmrubberparts.com](mailto:info@rpmrubberparts.com)

