

VMS-1657-65-M20 Marine Mount



Item # VMS-1657-65-M20 Marine Mount

Specifications

A (mm)	228
B (mm)	70
C (mm)	114
D (mm)	182
F (mm)	18
G (mm)	35
J (mm)	25
M (mm)	M20
S (mm)	5
Max Load (kg)	800

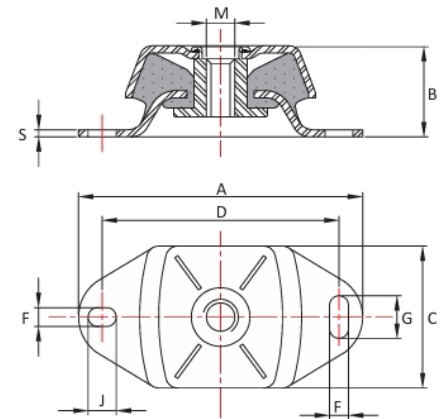

[Request for Quote](#)

[Contact Us](#)

USA
4392 Broadway
Depew, NY 14043

Canada
2290 Industrial Street
Burlington, Ontario
L7P 1A1

888.842.5668

905.335.5523

info@rpmrubberparts.com

