

# VSM-180102-2 Large Shear Mounts



**Item #** VSM-180102-2 Large Shear Mounts  
**Manufacturer:** RPM Mechanical Inc

## Specifications

A (in)	7.12
B (in)	7.12
C (in)	5.75
Compression Spring Rate Kc (Imperial)	5100
Compression Spring Rate Kc (Metric)	893
Compression Static Load (lbs)	3670
Compression Static Load (Metric)	16325
D (in)	5.75
E (in)	0.51
Elastomer	Natural Rubber
F (in)	4
F (mm)	101.6
Flange Thickness (in)	0.19

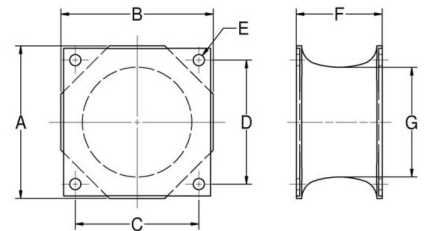
[Request for Quote](#)
[Contact Us](#)

**USA**  
 4392 Broadway  
 Depew, NY 14043

**Canada**  
 2290 Industrial Street  
 Burlington, Ontario  
 L7P 1A1

888.842.5668

905.335.5523

[info@rpmrubberparts.com](mailto:info@rpmrubberparts.com)



# VSM-180102-2 Large Shear Mounts



**Item #** VSM-180102-2 Large Shear Mounts  
**Manufacturer:** RPM Mechanical Inc

## Specifications (Continued)

<b>Flange Thickness (mm)</b>	<b>4.8</b>
<b>G (in)</b>	<b>5.5</b>
<b>G (mm)</b>	<b>139.7</b>
<b>Grade per SAE J429</b>	<b>2</b>
<b>Manufacturer</b>	<b>RPM Mechanical Inc.</b>
<b>Shear Spring Rate Ks (lbs/in)</b>	<b>850</b>
<b>Shear Spring Rate Ks (Metric)</b>	<b>149</b>
<b>Shear Static Load (lbs)</b>	<b>770</b>
<b>Shear Static Load (Metric)</b>	<b>3425</b>
<b>Types</b>	<b>5L</b>

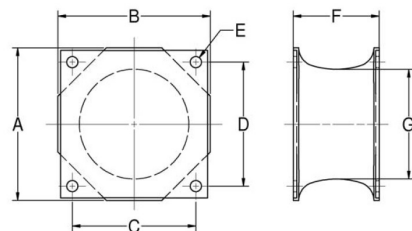

[Request for Quote](#)

[Contact Us](#)

**USA**  
 4392 Broadway  
 Depew, NY 14043

**Canada**  
 2290 Industrial Street  
 Burlington, Ontario  
 L7P 1A1

888.842.5668

905.335.5523

[info@rpmrubberparts.com](mailto:info@rpmrubberparts.com)

